

USE OF THE BEN FRANKLIN SUBMERSIBLE
AS A SPACE STATION ANALOG

Volume III – Habitability
OSR-70-6

Prepared for
National Aeronautics and Space Administration
George C. Marshall Space Flight Center
Advanced Systems Office

Contract NAS 8-30172

Prepared by
Space Station Analog Study Team

APPROVED BY



M. J. FERGUSON, *Study Manager*

May 1970

THE BEN FRANKLIN DURING THE GULF STREAM DRIFT MISSION

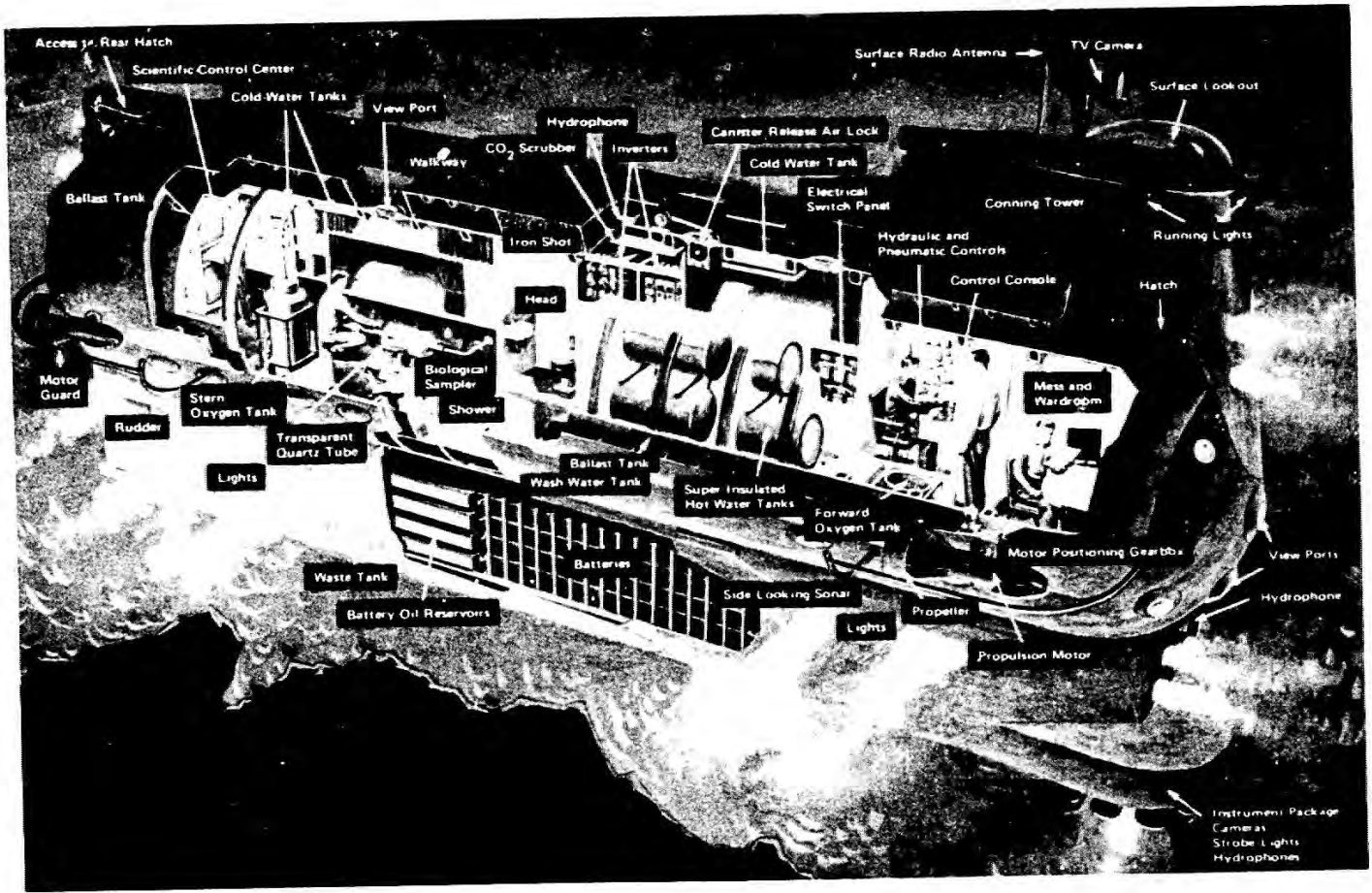
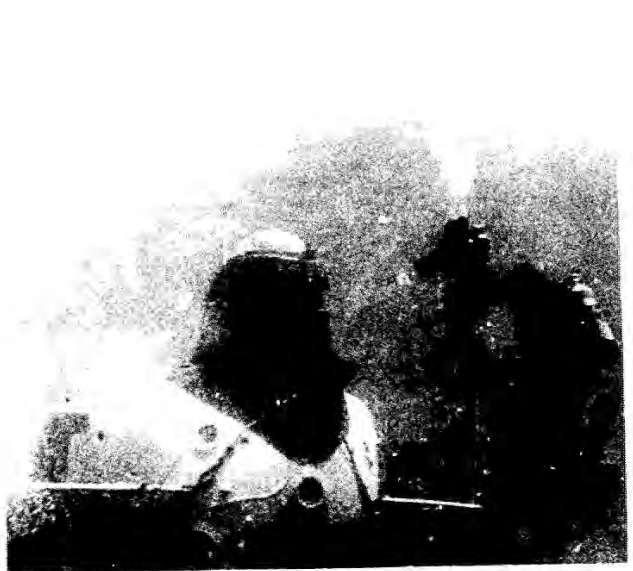
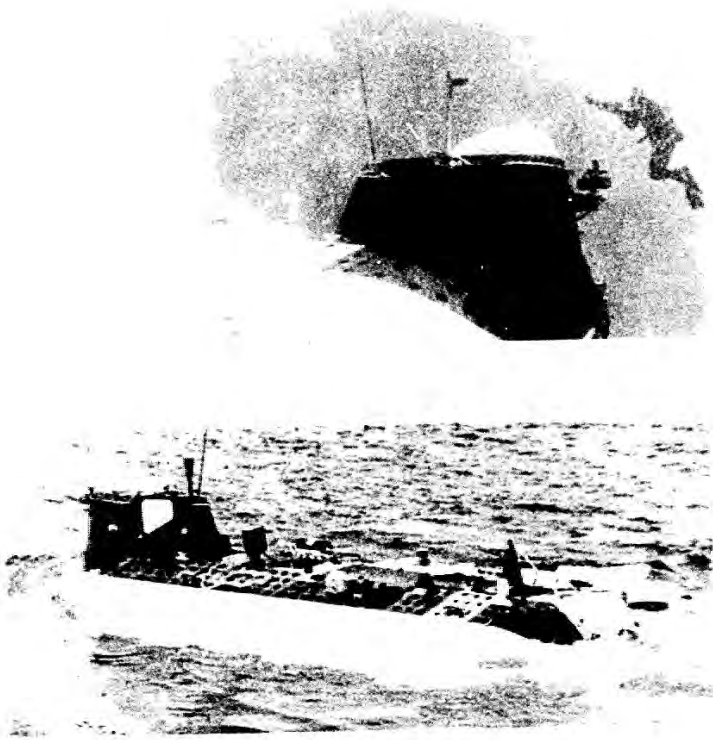

FOREWORD

During 1969, the Ocean Systems Department of Grumman Aerospace Corporation conducted the 30-day Gulf Stream Drift Mission, using the BEN FRANKLIN submersible. As a part of this mission, a NASA study was conducted to investigate man related activities which are analogous to long-duration space station missions. During the mission, a NASA crew member was aboard the BEN FRANKLIN for data collection, observation, and task participation. This work was performed in accordance with the Statement of Work in NASA Contract NAS 8-30172, "Use of BEN FRANKLIN as a Space Station Analog," for the George C. Marshall Space Flight Center, Advanced Systems Office, under the direction of C. B. May. The program was coordinated by Manager M. F. Markey of NASA, Washington Headquarters.

The Final Report consists of the following five volumes:

- OSR-70-4, Volume I, Summary Technical Report
- OSR-70-5, Volume II, Psychology and Physiology
- OSR-70-6, Volume III, Habitability
- OSR-70-7, Volume IV, Microbiology
- OSR-70-8, Volume V, Maintainability

CONTRIBUTORS

Contributors to this study were:

Dr. Milton Delucchi	NASA, Manned Space
Mr. I. Donenfeld	Naval Medical Research
E. Dougherty, Ph.D.	Naval Medical Research
Mr. E. Fisher	NASA, Marshall Space Flight
Dr. J. Frost	Baylor University
Mr. W. Funston	NASA, Marshall Space Flight
B. A. Gropper, Ph.D.	Bellcomm, Consultant for NASA
W. W. Haythorn, Ph.D.	Naval Medical Research
Mr. R. Heckman	NASA, Marshall Space Flight (Backup crew member)
Mr. A. C. Krupnick	NASA, Marshall Space Flight
E. J. McLaughlin, Ph.D.	NASA, Space Medicine
Dr. J. N. Scow	NASA, Langley Research
Dr. S. Smith	Naval Medical Research
W. W. Umbreit, Ph.D.	Rutgers University

ABSTRACT

This report presents the NASA effort using the BEN FRANKLIN submersible as a space station analog during the 30-day Drift Mission in the Gulf Stream, starting July 14 and ending August 14, 1969. The areas of investigation include:

- Psychological and Physiological measurements during the pre-mission, mission, and post-mission phases
- Habitability in a closed ecosystem
- Microbiological evaluation of the water system, human flora, and environmental samples
- Maintainability considerations for scheduled and unscheduled tasks.

AUTHOR CREDIT

The five volumes were prepared by the Space Station Analog Team as follows:

<u>Subject</u>	<u>Author(s)</u>
● Psychology and Physiology	C. P. Seitz, Ph. D.; A. Goldman, Ph. D.; R. J. Del Vecchio, Ph. D.; C. J. Phillips, Ph. D.
● Medical	R. P. Jessup, M.D.; R. Fagin, M.D.
● Habitability	
- Habitability Analysis	M. J. Ferguson
- Environmental	F. Abeles, N. Kamen
● Microbiology	D. Valentine, K. Feindler, R. F. Davis
● Maintainability	J. R. Kappler, R. Toussaint
● Oceanographic Experiments	H. Reichel
● Summary	M. J. Ferguson

CONTENTS

Section		Page
1	INTRODUCTION	1-1
2	HABITABILITY ANALYSIS	2-1
	2.1 Method of Analysis	2-1
	2.2 Limits of Analysis	2-4
	2.3 Area Utilization	2-9
	2.4 Crew Activity	2-16
	2.5 Crew Time Lines	2-18
	2.6 Habitabilities Planning Considerations	2-24
3	ENVIRONMENTAL ANALYSIS	3-1
	3.1 Instruments	3-1
	3.2 Procedures	3-5
	3.3 Pre-mission Training and Experience	3-5
	3.4 Mission Data	3-6
4	FOOD MANAGEMENT	4-1
	4.1 Basic Requirements	4-1
	4.2 Food System	4-1
	4.3 Crew Acceptance	4-3
5	WATER MANAGEMENT	5-1
	5.1 Distribution	5-1
	5.2 Allocation	5-1
	5.3 Cold Water	5-5
	5.4 Hot Water	5-5

CONTENTS (Cont.)

Section		Page
6	CLOTHING AND BEDDING	6-1
	6.1 Clothing	6-1
	6.2 Coveralls	6-2
	6.3 Mattresses	6-2
	6.4 Sheets, Pillowcases and Blankets	6-2
7	PERSONAL HYGIENE	7-1
8	NOISE LEVELS	8-1
9	LIGHT LEVELS	9-1
10	FREE VOLUMES AND AREAS	10-1
11	SUBJECTIVE HABITABILITY DATA	11-1
12	CONCLUSIONS AND RECOMMENDATIONS	12-1
	12.1 Habitability Analysis	12-1
	12.2 Environment	12-1
	12.3 Food	12-1
	12.4 Water	12-1
	12.5 Clothing	12-2
	12.6 Bunks	12-2
	12.7 Hygiene	12-2
	12.8 Housekeeping	12-2
	12.9 Area Utilization	12-2
	12.10 Noise	12-3
	12.11 Light	12-3

CONTENTS (Cont.)

Appendix	Page
A CREW ACTIVITY ANALYSIS	A-1
B CREW TIME LOCATION ANALYSIS	B-1
C INSTRUMENTS FOR ENVIRONMENT MEASUREMENT	C-1
D GULF STREAM DRIFT MISSION MENU	D-1

ILLUSTRATIONS

Figure No.		Page
2-1	Camera Locations	2-2
2-2	Film Viewing Layout	2-3
2-3	Computer Card Format	2-5
2-4	Fortran Activity Codes (3 Sheets)	2-6
2-5	Area Utilization Crew versus Location, Day 1	2-10
2-6	Area Utilization Crew versus Location, Day 6	2-11
2-7	Area Utilization Crew versus Location, Day 8	2-12
2-8	Area Utilization Crew versus Location, Day 25	2-13
2-9	Area Utilization Crew Reading, Day 8	2-14
2-10	Area Utilization Writing, Day 8	2-15
2-11	Crew Activity, Crewman 1, Day 1, 15 July 1969	2-17
2-12	Total Reading, Days 2, 6, 8, 25 (Entire Crew)	2-19
2-13	Total Writing, Days 2, 6, 8, 25 (Entire Crew)	2-19
2-14	Overview Crew Time Distribution, Day 1	2-20
2-15	Typical Planned Crew Time Lines	2-21
2-16	Actual versus Planned Time Line, Man 1, Day 1, 6, 8, 25	2-23
3-1	Sources and Production Rates of Volatile Metabolically Generated Contaminants	3-2
3-2	Environmental Analysis	3-3
3-3	Environmental Measurements	3-4
3-4	Log of Air Pressure, CO ₂ and O ₂	3-7
3-5	Log of Temperature and Relative Humidity	3-10
3-6	Results of Gas Analysis Using the Gas Chromatograph	3-12
4-1	Galley Area - Food Preparation	4-2
4-2	Food and Hot Water Complaints	4-5

ILLUSTRATIONS (Cont.)

Figure No.		Page
5-1	The Ben Franklin	5-2
5-2	Hot Water Tank Temperature Decay Curve	5-3
5-3	Water Management System	5-3
5-4	Potable Water Budget	5-4
6-1	Clothing Complaints	6-3
6-2	Bedding Complaints	6-3
7-1	Hygiene Facility	7-2
7-2	Odor Control Complaints	7-3
8-1	Noise Level Measurements	8-2
8-2	Typical Power Levels for Various Acoustic Sources	8-3
8-3	Noise Complaints	8-4
9-1	Location Diagram for Making Noise Illumination Measurements	9-2
9-2	Illumination Level Versus Source	9-3
9-3	Light Level Complaints	9-4
10-1	Areas and Volumes	10-2
10-2	Free Volumes (Recommended Versus Available)	10-2
10-3	Relaxation	10-4
10-4	Habitability	10-5
10-5	Habitability Activity Day 1	10-6
10-6	Habitability Activity Day 25	10-7
10-7	Privacy and Free Space Complaints	10-8
10-8	Tolerance of Confinement and Acceptable Space Cabin	
	Requirements	10-9
11-1	Overall Habitability Complaints	11-2
11-2	Major Habitability Complaints	11-2

SECTION 1
INTRODUCTION

The objectives of the habitability study under NASA contract on the Gulf Stream Drift Mission (GSDM) were:

- 1) to explore the habitability provisions for the purpose of obtaining space station design criteria
- 2) to determine if the data from the mission is applicable to space station design.

The study included an analysis of crew activities and area utilization, and the environmental control, food, water, clothing, bedding and personal hygiene provisions.

The Ben Franklin was designed with the GSDM scientific ocean investigations as the driving force. The interior arrangement was also influenced by the lack of detail data during the early design phase on the requirements for submersible and scientific equipment. Since a liberal space allowance was made for their eventual installation, this reduced the volume available for crew provisions. The habitability provisions were also restricted by various vehicle limitations. For example, a passive environmental control system was selected to conserve power. Finally, the NASA contract was awarded after the vehicle design was well established and spacecraft design concepts or hardware could not be incorporated.

Indirect study techniques were used on the GSDM because direct observation was impossible. Three cameras were strategically placed to photograph all areas of the vehicle except the sleeping quarters and personal hygiene areas. Pictures taken at two-minute intervals, various logs, crew conversation tapes, and records of on-board instrumentation provided data for post-mission analysis.

SECTION 2

HABITABILITY ANALYSIS

The BEN FRANKLIN interior was photographed every two minutes by three synchronized time-lapse cameras (Figure 2-1 shows the camera location and fields-of-view) to obtain data for area utilization and crew activity studies. After a general review for general activity patterns, the pictures taken on four mission days representing significant mission phases were selected for detailed review:

- 1st Mission Day (first Bottom Survey)
- 8th Mission Day (last Bottom Survey)
- 6th Mission Day (early mission drift day)
- 25th Mission Day (late mission drift day)

These early and late mission dive/drift days were reviewed to determine changes in crew activity, crew time-lines, and area utilization. Variations from pre-planned activity were anticipated because the oceanographic mission was exploratory, and the crew had not previously worked or relaxed together for extended periods.

2.1 METHOD OF ANALYSIS

Three time-lapse pictures were simultaneously projected showing the entire interior of the vehicle except the private area for a given time on a given mission day. The time was synchronized with clocks in the field of view of the cameras. The layout for viewing the film data is illustrated in Figure 2-2.

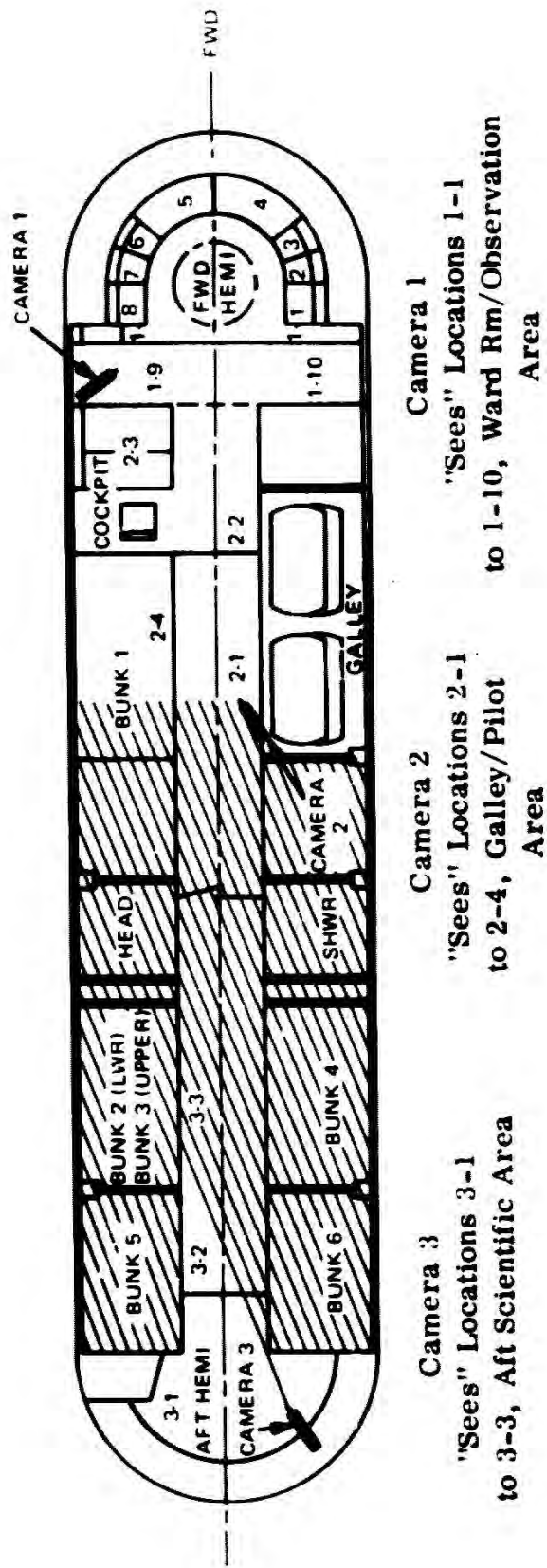

Note: Private area is shaded

Figure 2-1. Camera Locations

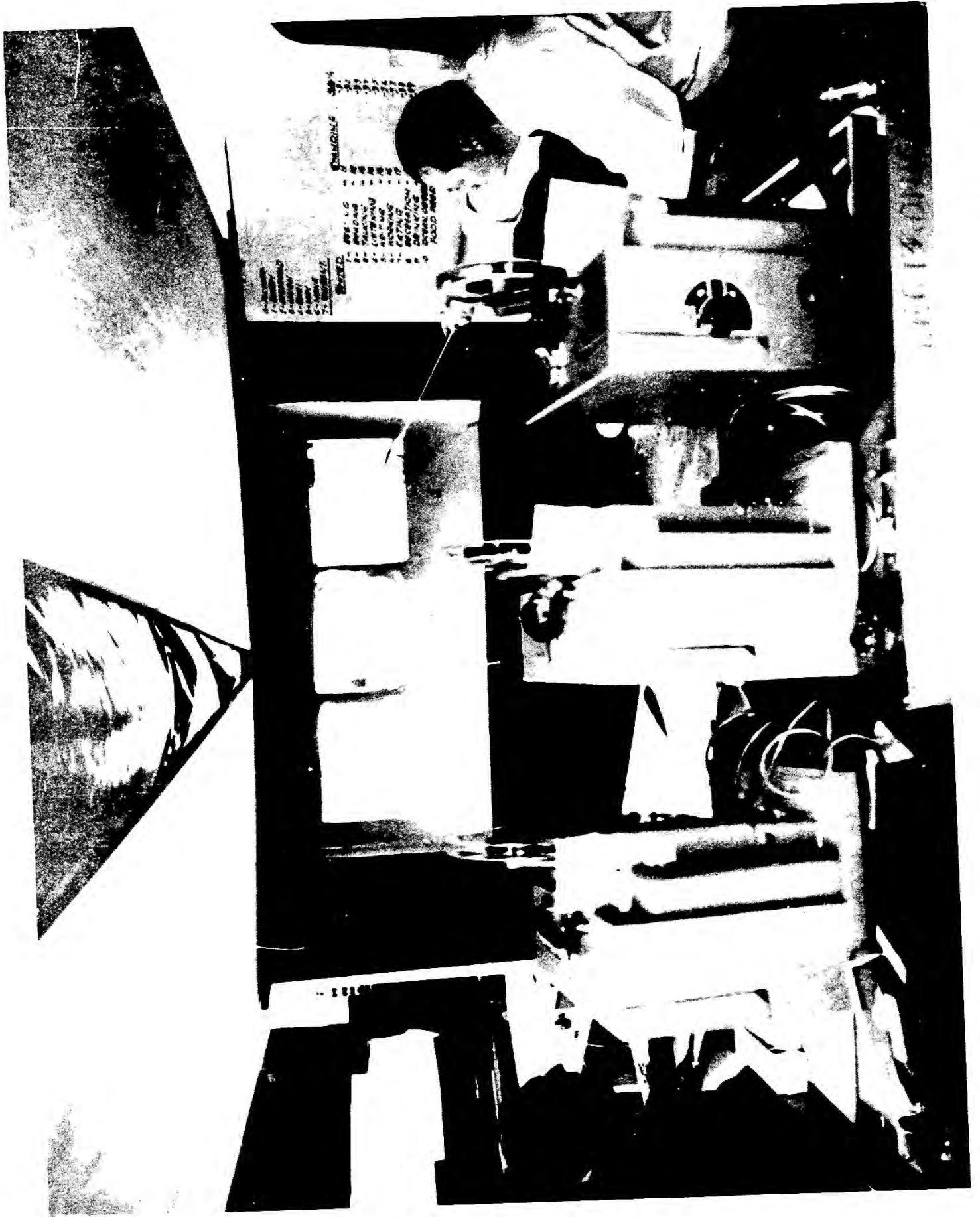

Figure 2-2. Film Viewing Layout

The data from the photographs and logs were recorded on Fortran sheets (Figure 2-3) with the code illustrated in Figure 2-4. The intent of documenting all of the data on the Fortran sheets was to provide answers to the following:

- How did the crew members use the vehicle?
- Where did each crew member work, write, read, etc?
- Did the crew members spatially interfere with one another's activity?
- How did the crew members perform the required work at the same time?
- Did the crew members work around obstructions with apparent ease?
- How long did individuals stay on the job to perform a task?
- Was there an apparent tendency to get tired and leave the work and return later?
- What is the time history for individual crew members?
- Did the crew follow the time lines planned for the mission?
- When and why did the crew members deviate from the planned time line?
- Did the crew become more or less active as the mission continued?
- Are task categories identifiable (e.g., maintainability tasks, microbiology tasks)?

2.2 LIMITS OF ANALYSIS

The data from Days 1, 6, 8, and 25 were selected as representative bases for determining the limits of the analysis.

One limiting factor was lack of appropriate lighting for optimum photographic contrast and clarity. Changes in light levels in the vehicle during the mission resulted in poor quality pictures at random intervals. The cameras could not be reworked for automatic compensation to the various light levels prior to the mission. They were not reset by crew members during the mission, because it was thought that working with the cameras would only remind the crew that their activity was being photographed and possibly irritate them.

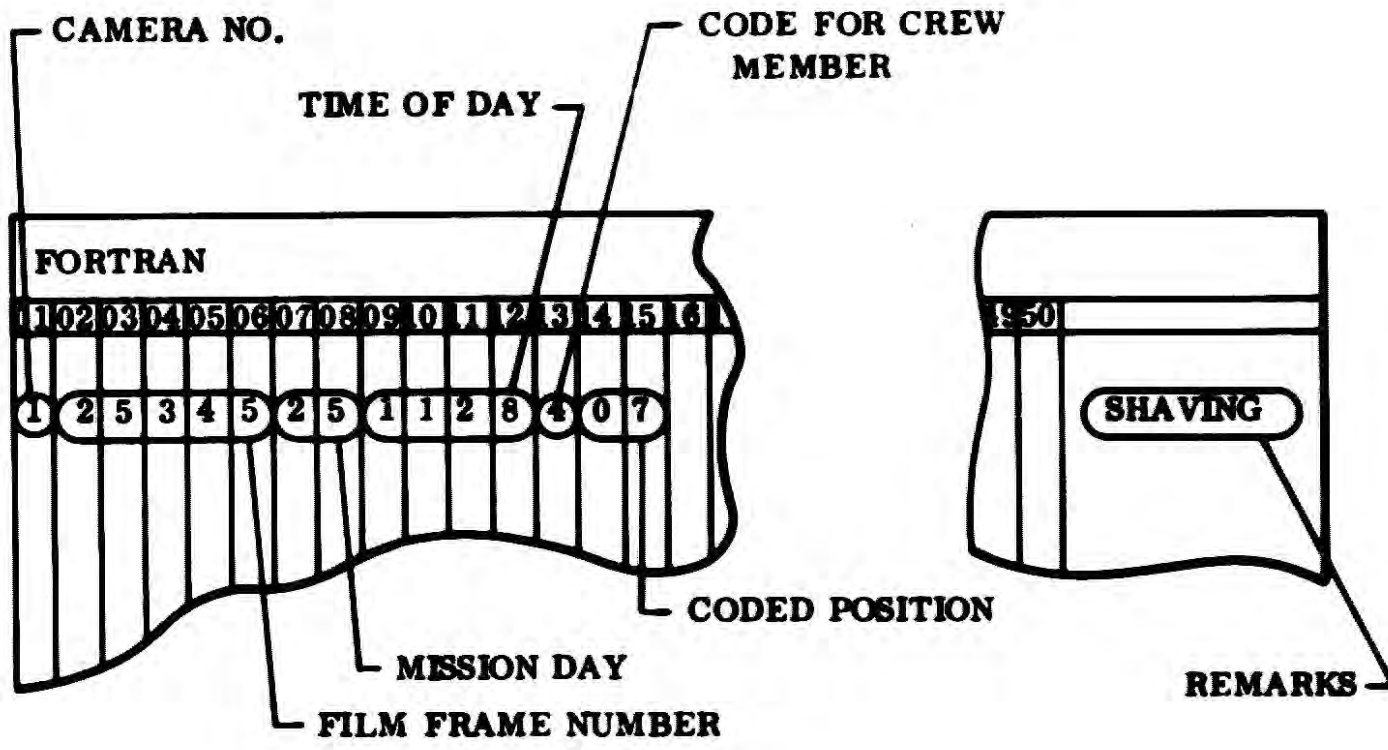

Figure 2-3. Computer Card Format

FORTRAN ACTIVITY CODES

PERSONNEL

Crew Man	1
Crew Man	2
Crew Man	3
Crew Man	4
Crew Man	5
Crew Man	6
None Shown	7
Unidentified	8

PHYSICAL POSITION

<u>Activity</u>	<u>Seated</u>	<u>Standing</u>	<u>Squatting</u>
Resting	-01-	-11-	-31-
Reading	-02-	-12-	-32-
Talking	-03-	-13-	-33-
Listening	-04-	-14-	-34-
Writing	-05-	-15-	-35-
Working	-06-	-16-	-36-
Eating	-07-	-17-	-37-
Recreation	-08-	-18-	-38-
Drinking	-09-	-20-	-39-
Oceanographic*	-10-		
Food Preparation	-20-		
Walking	-21-		
Running	-22-		
Sleeping (Seated)	-23-		
Unused	-24-		

*Day 1 only

Figure 2-4. Fortran Activity Codes (Sheet 1 of 3)

PHYSICAL POSITION (Con't)

<u>Activity</u>	<u>Seated</u>	<u>Standing</u>	<u>Squatting</u>
Kneeling	-25-		
Prone Aft Hemi**	-26-		
Prone Fwd Hemi**	-27-		
Prone in Bunk	-28-		
Seated in Bunk	-29-		

**Day 6, 8 and 25 = Ocean OB.

ACTIVITY IDENTIFICATION

-20- Talking		Listening -40-
-21- Talking	Personal	Listening -41-
-22- Talking	News	Listening -42-
-23- Talking	Plans	Listening -43-
-24- Talking	Vehicle Operation	Listening -44-
-25- Talking	Vehicle Performance	Listening -45-
-26- Talking	Watch Duties	Listening -46-
-27- Talking	B. F. Sys. Condition	Listening -47-
-28- Talking	Scientific Experiment	Listening -48-
-29- Talking	Support Ship Operations	Listening -49-
-30- Talking	Support Ship Command/Control	Listening -50-
-31- Talking	Support Ship Command/Decision	Listening -51-
-32- Talking	Conversation Initiated	Listening -52-
-33- Talking	Giving Directions	Listening -53-
-34- Talking	Giving Advice	Listening -54-

Figure 2-4. Fortran Activity Codes (Sheet 2 of 3)

ACTIVITY IDENTIFICATION (Con't)

- | | |
|------------------------------------|--|
| -60- Writing | -80- Microbiology |
| -61- Diary | -81- Micro Human Flora |
| -62- Personal Log | -82- Micro Environmental |
| -63- Data Sheet | -83- Micro Water |
| -64- Pilot's Log | |
| | -90- Environmental |
| -70- Working | -91- Environmental Drager Tubes |
| -71- Maintainability | -92- Environmental Fyrite O₂ |
| -72- Maintaining B. F. Sys. | -93- Environmental Teledyne O₂ |
| -73- NASA Equipt. | -94- Environmental Gas
Chromatograph |
| -74- NAVO Equipt. | -95- Air Sample |
| -75- Unidentified Equipt. | -100- Scientific Exper. |

Figure 2-4. Fortran Activity Codes (Sheet 3 of 3)

A second limiting factor was that the crew wore uniforms without personal identifying marks; therefore, more time was required to establish the activity of all crew members. To compensate for this limitation, it was necessary to become very familiar with each crew member's appearance. When there was a disagreement in identification, the crew member was coded as unidentified.

The third limiting factor was the fact that crew members could spend long periods of time in the private area out of range of the cameras (Figure 2-1). It was necessary to refer to the various logs to confirm where the crew members were at a given time. (It is interesting to note that the data recorded by the MAN 3 were substantiated by the time-lapse pictures.)

The fourth limiting factor was that the task being performed could not always be identified. In this case the data is recorded simply as a crew member working. If the work could be identified, it was coded as shown in Figure 2-4.

The fifth limiting factor was that the time between pictures prevented a detail study of the scientists performing oceanographic experiments and maintenance actions. However, the overall picture of various activities was obtained.

Even with these limitations, it was possible to observe the crew's scientific, operational and social activity in an overall sense, determine area utilization, and to compare the actual crew time lines with the planned time lines.

2.3 AREA UTILIZATION

The area utilization data include the results from the three cameras. Each crew member in view of the cameras is identified. The data do not identify what the crew is doing, but identify where each crewman was "observed the most" for each hour during days 1, 6, 8 and 25 (Figures 2-5 through 2-8). These data were developed from work sheets which identify where each crew member was observed in the vehicle. When an individual's symbol is not shown, the man is presumed to be in the private area. Separate data sheets (Figures 2-9 and 2-10) identify crew activity.

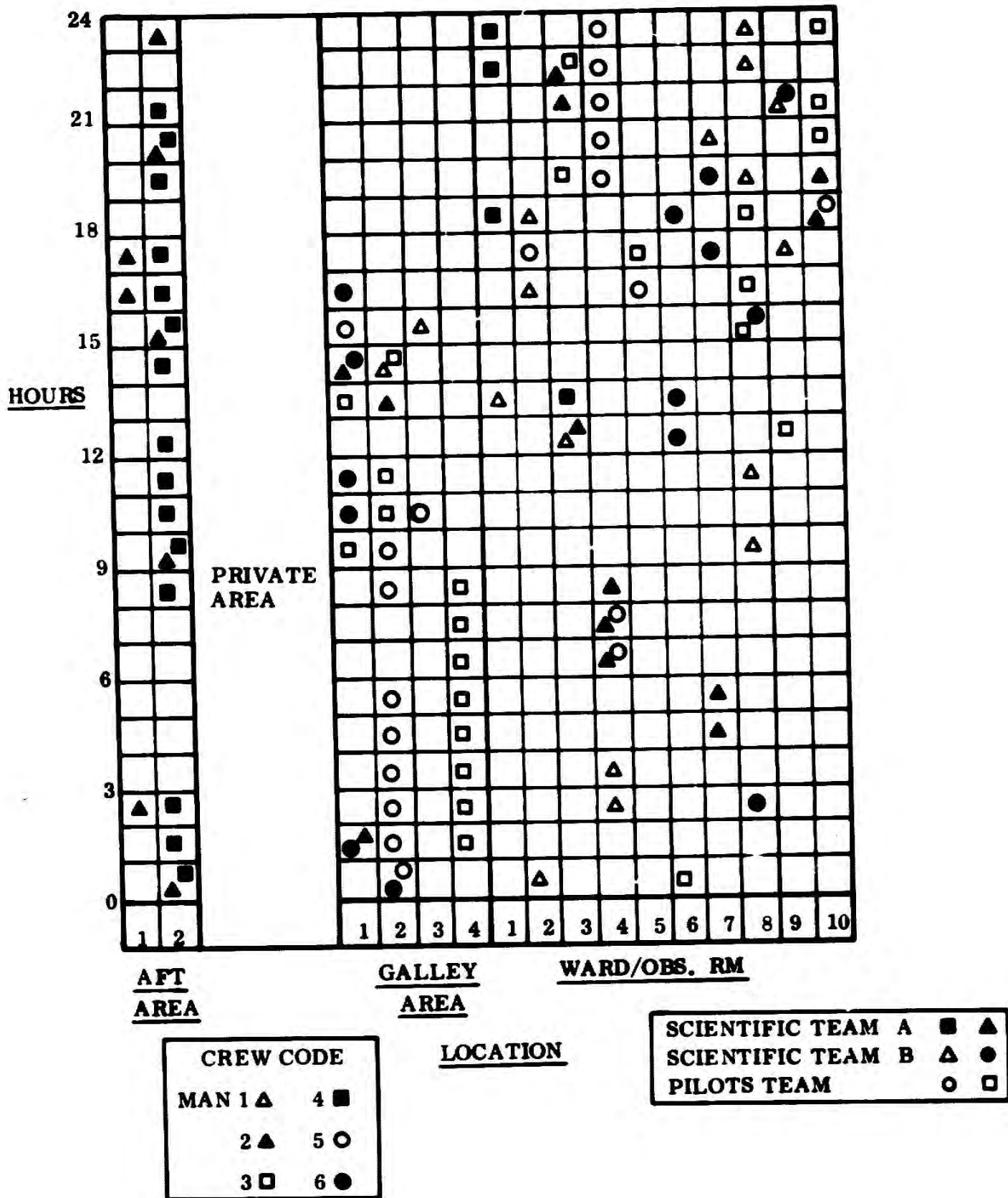

Figure 2-5. Area Utilization, Crew versus Location, Day 1

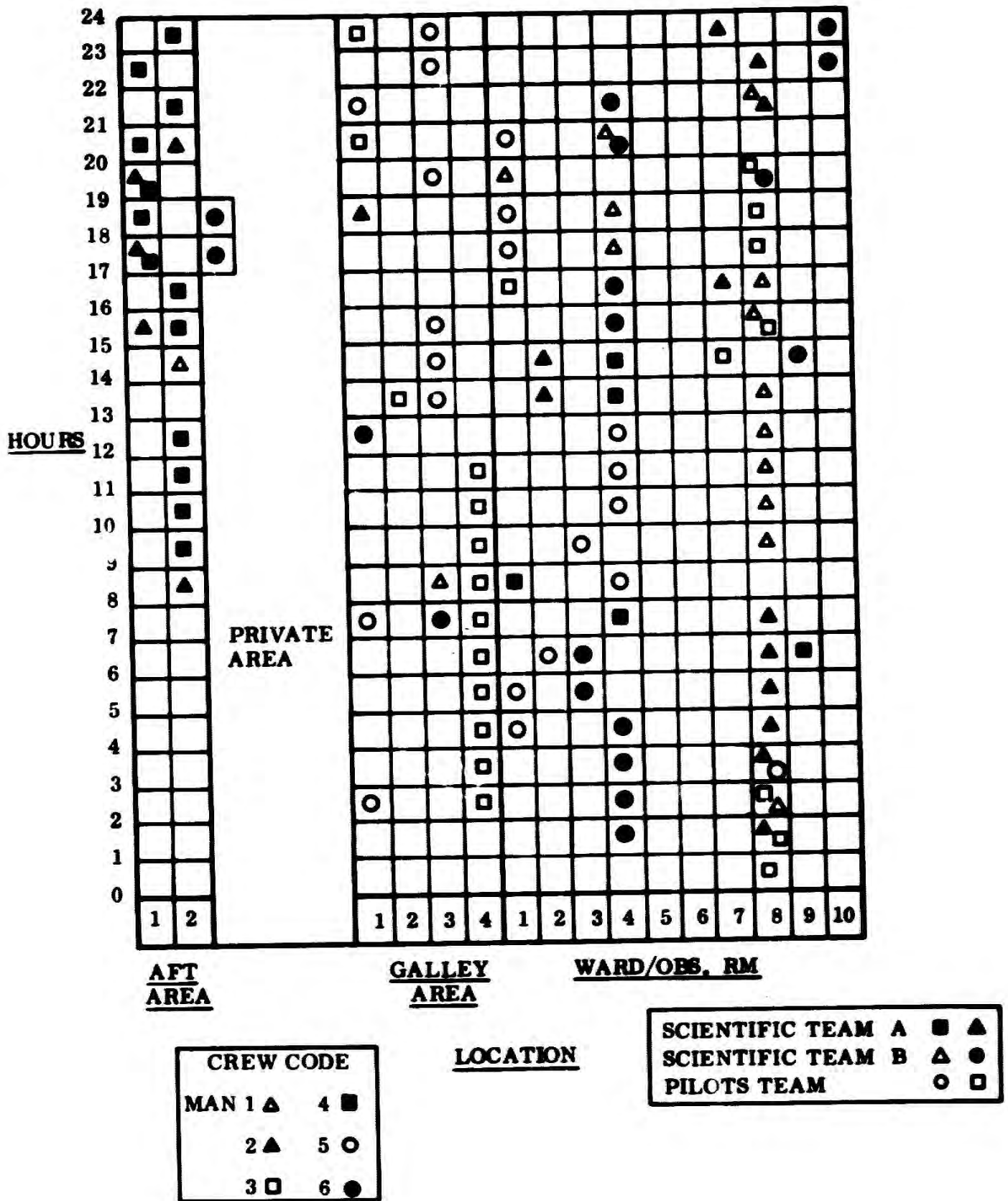

Figure 2-6. Area Utilization, Crew versus Location, Day 6

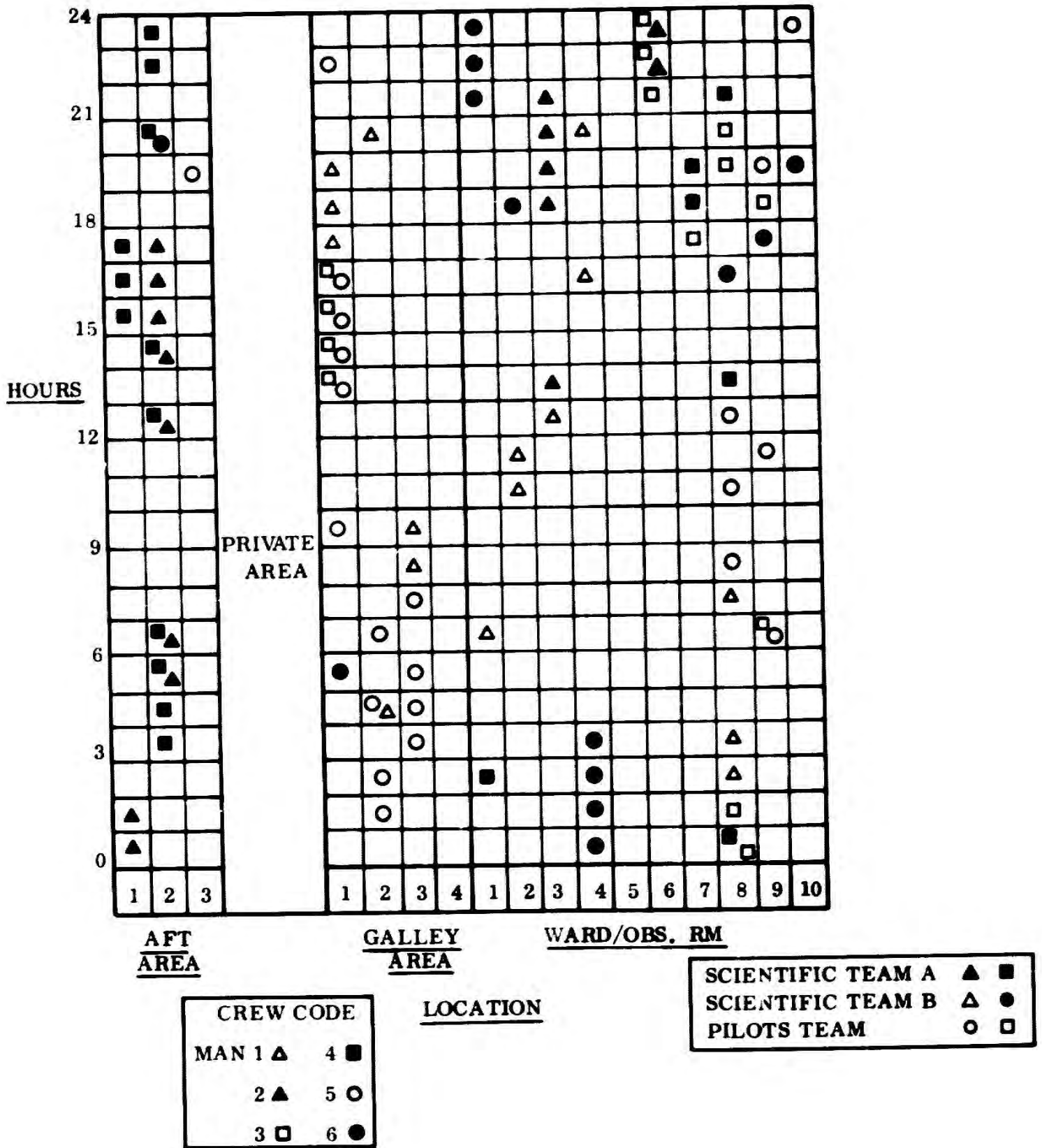

Figure 2-7. Area Utilization, Crew versus Location, Day 8

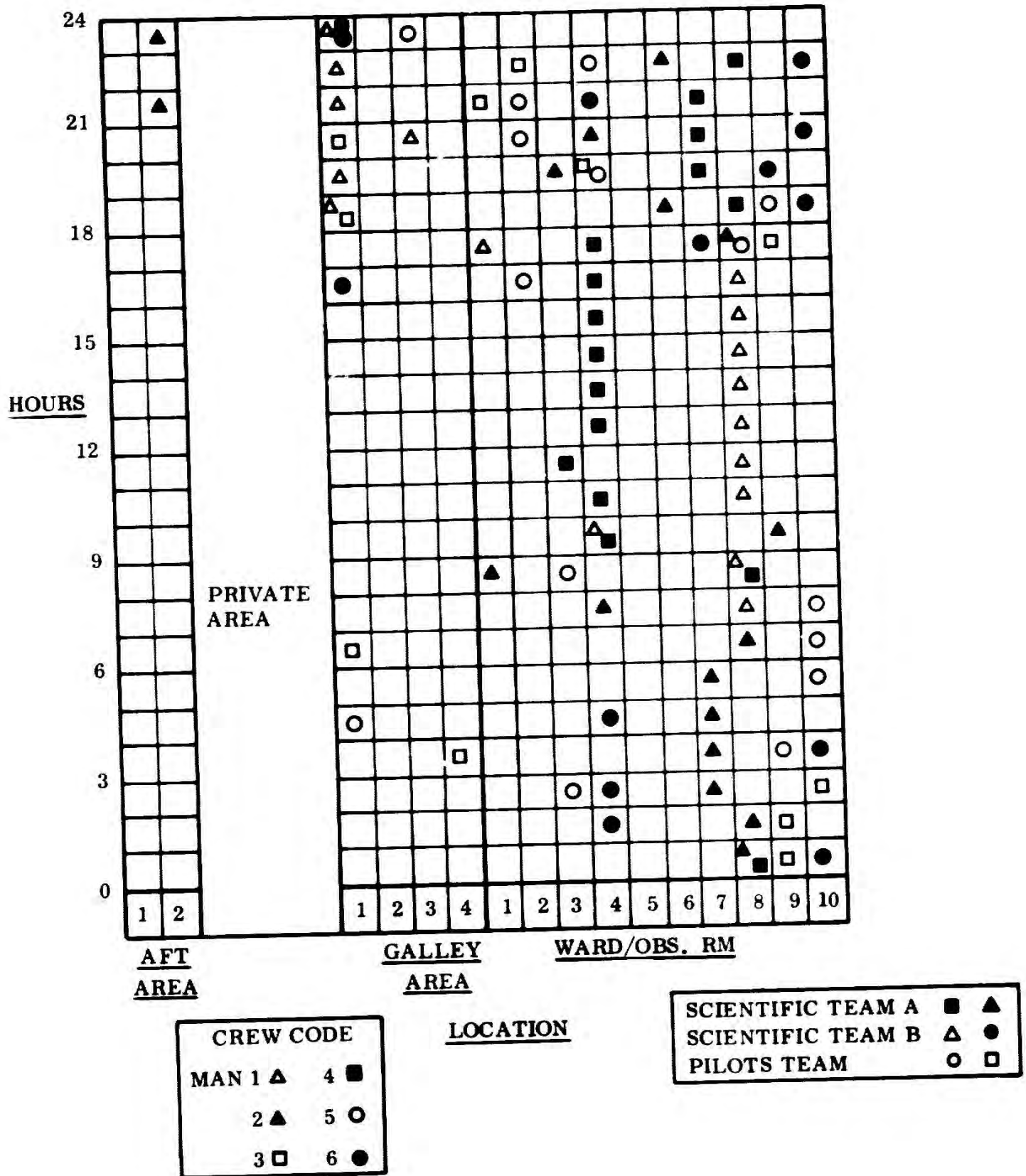

Figure 2-8. Area Utilization, Crew versus Location, Day 25

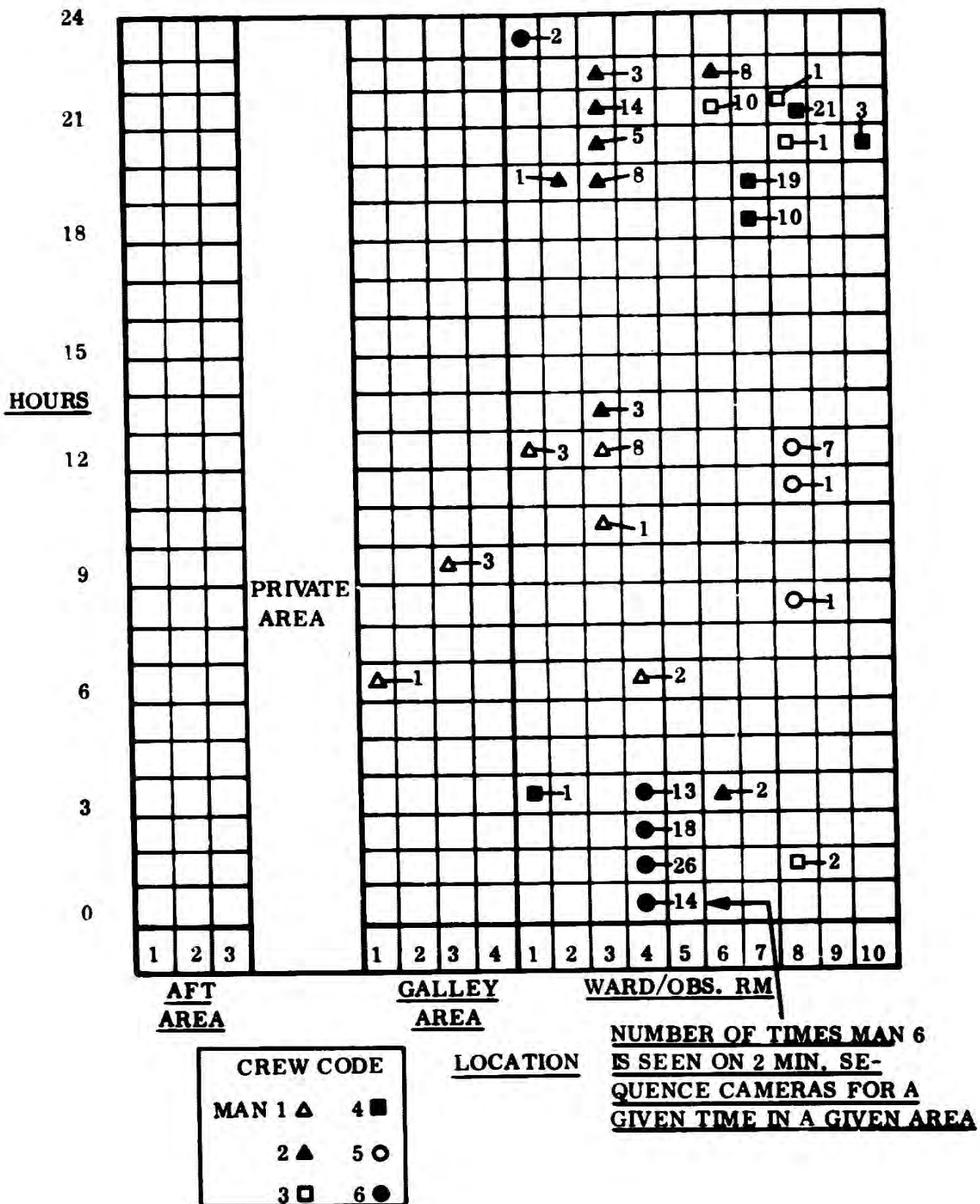

Figure 2-9. Area Utilization, Crew Reading, Day 8

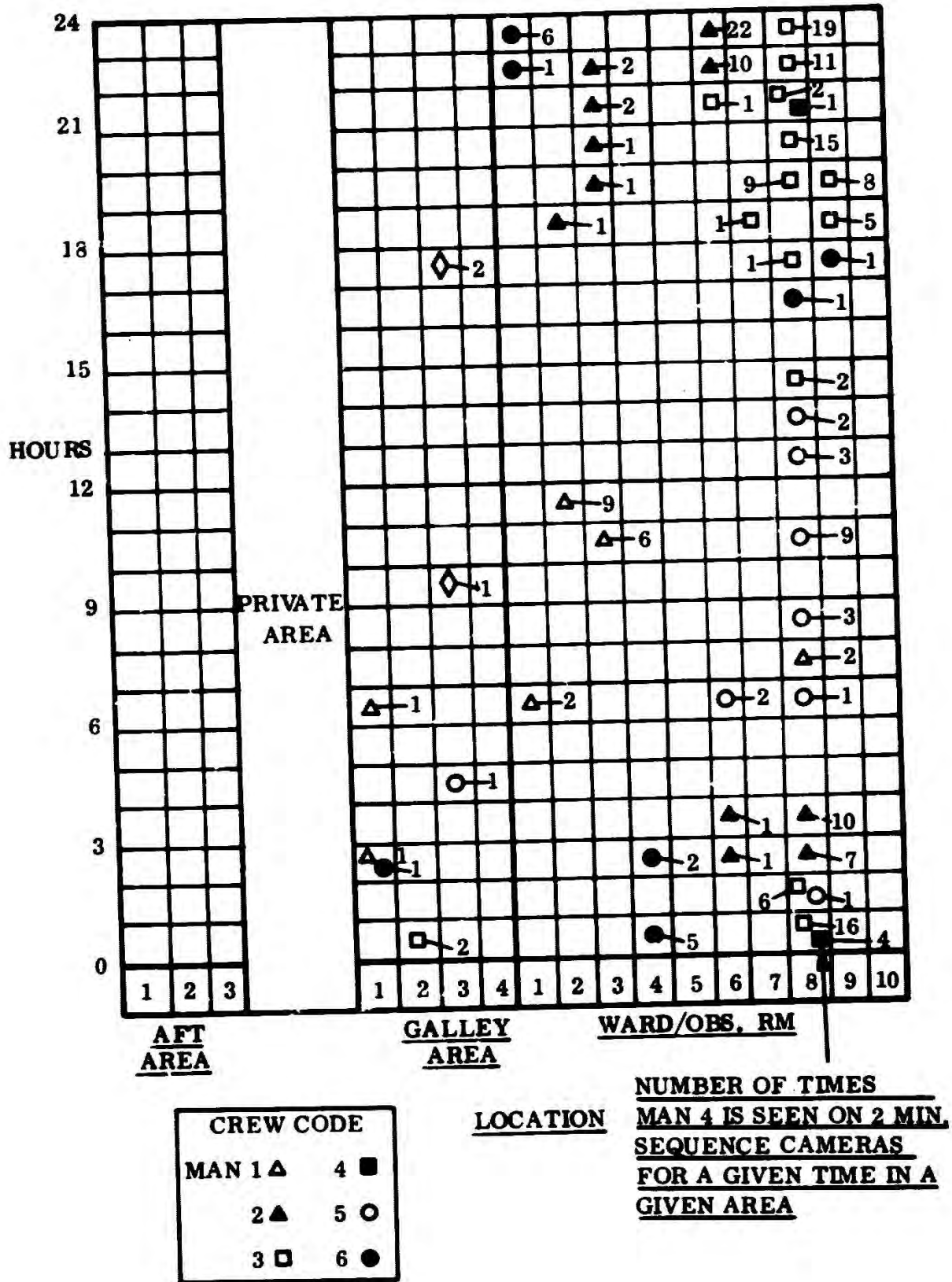

Figure 2-10. Area Utilization, Writing, Day 8

The data are useful for obtaining insight on crew activity by location, and determining (1) which crew members worked together, (2) the time spent by each in his work area, and (3) how often and when the scientific teams and pilots were in the same area. For instance, scientific team "A" was in the same area during the first bottom survey (Day 1) for six hours (Figure 2-5). During the same day, one of the pilots (crewman 5) worked eight hours straight (from midnight to 0800 hours) and checked the vehicle until 1000 hours because of his concern for avoiding a collision.

The area utilization study is helpful for crew observation and to determine how the crew used the BEN FRANKLIN during various stages of the mission. These data were supplemented with crew activity data for developing actual crew time lines.

2.4 CREW ACTIVITY

After the area utilization study, a detail description of crew activity was developed from the Fortran Sheets, the various logs (Ship's, Captain's, Communication, and Crew Member's), and the crew debriefing.

The activity of one crew member for the Day 1 is illustrated in Figure 2-11.

The fourteen items listed in the figure account for all activities identified on Day 1. The abscissa is the hour of the day and the ordinate is the number of photographic frames (30 frames for each hour). The activities are categorically grouped along the ordinate to reflect the percentage of like activity in each hour instead presenting their chronology. The activities considered are:

- Sit and/or stand working
- Sit and/or stand reading
- Sit and/or stand writing
- Oceanographic observations
- Sit and/or stand talking
- Sit and/or stand listening

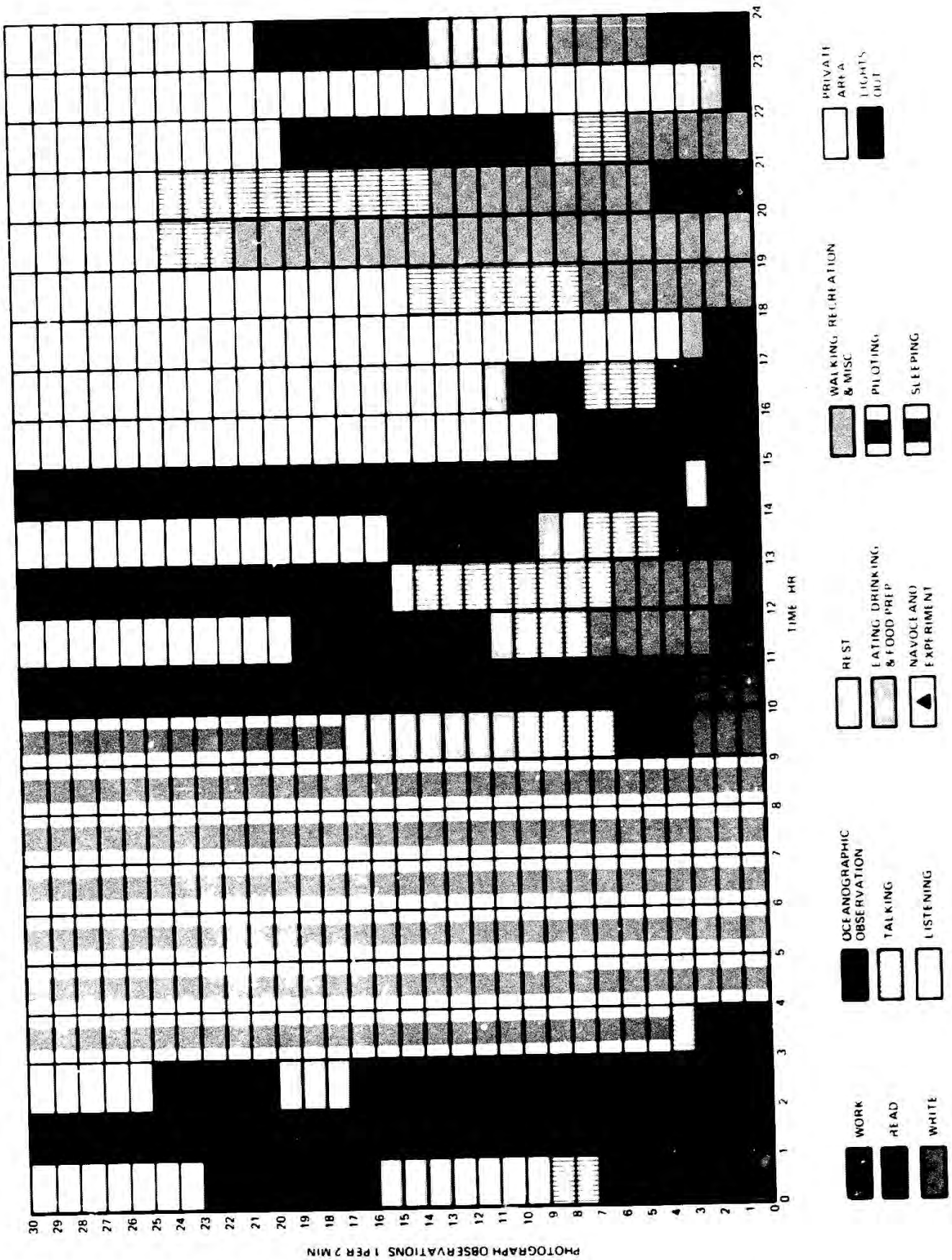

Figure 2-11. Crew Activity, Crewman 1, Day 1, 15 July 1969

- Sit and/or stand resting
- Eating, drinking and food preparation
- NAVOCEANO experiments
- Walking, recreation, misc.
- Piloting
- Sleeping
- Lights out for oceanographic observation
- Time spent in the private area

Some of the data are plotted to illustrate changes in crew activity. For example, the reading and writing for all crew members changed during the mission as illustrated in Figures 2-12 and 2-13.

The activity data give an overview of what each crewman was doing in relation to the mission activity and the objectives at the time.

From the Fortran sheets and the logs, each crew member's activity was identified for Days 1 and 25. The data from Day 1 (Appendix A) are given as an example of the information which can be extracted from the mission data.

Figure 2-14 presents an overview of how the crew members distributed their time during Day 1. These data were reorganized in terms of crew time lines by considering each man's location versus time when he performed his tasks. The crew time location presentation is discussed in the following paragraphs.

2.5 CREW TIME LINES

Individual task assignments were used to develop time lines based on the following:

- Three two-man teams were identified for vehicle operations and scientific experiments.
- Tasks were identified as illustrated in Figure 2-15.
- The scientists, vehicle operator teams, and individuals could work independently.

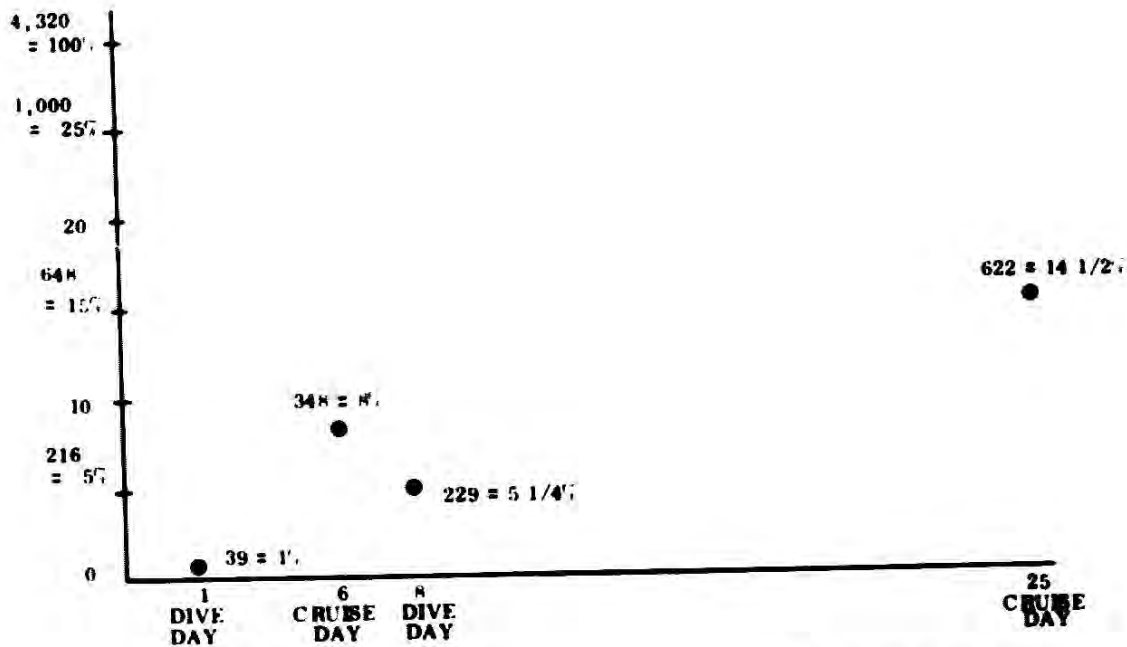

BASED ON: 4,320 = 100%
POSSIBLE TIMES A MAN
COULD BE SEEN ON A GIVEN
CAMERA FOR A GIVEN TIME

NOTE: THIS DOES NOT
ACCOUNT FOR READING
IN THE PRIVATE AREA

Figure 2-12. Total Reading, Days 2, 6, 8, 25 (Entire Crew)

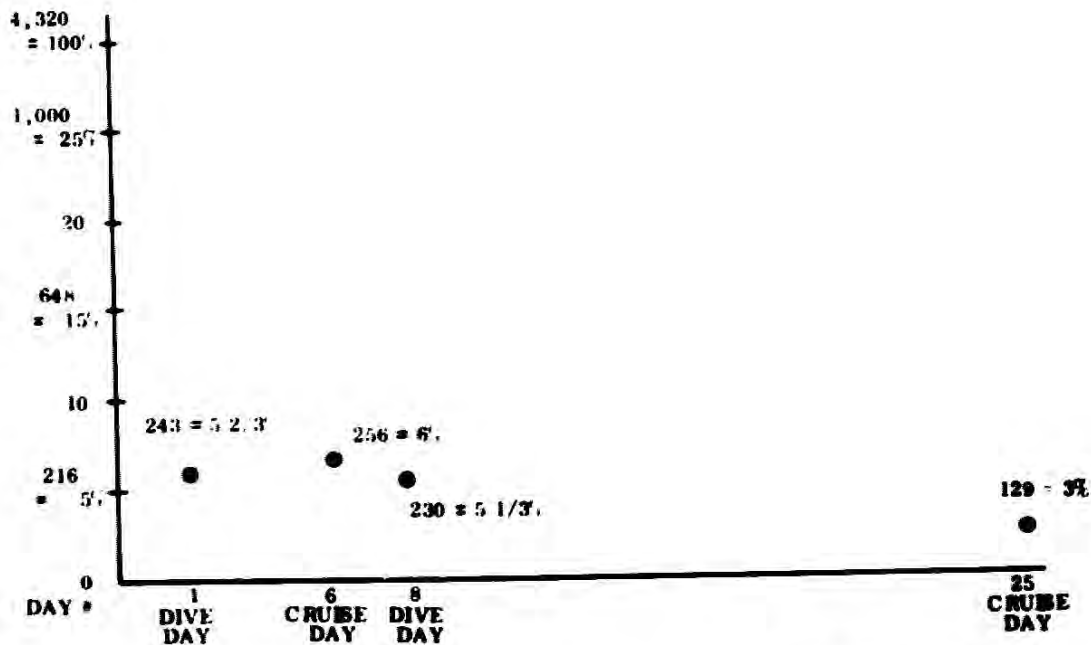

BASED ON: 4,320 = 100%
POSSIBLE TIMES A MAN
COULD BE SEEN ON A GIVEN
CAMERA FOR A GIVEN TIME

NOTE: THIS DOES NOT
ACCOUNT FOR WRITING
IN THE PRIVATE AREA

Figure 2-13. Total Writing, Days 2, 6, 8, 25 (Entire Crew)

CREW MAN	1		2		3		4		5		6	
	Hr.	Min.	Hr.	Min.	Hr.	Min.	Hr.	Min.	Hr.	Min.	Hr.	Min.
Sleep ⁽¹⁾	6	18	-	-	7	8	3	56	-	-	7	-
Activity ⁽²⁾	11	16	14	48	13	32	14	-	21	32	10	-
Food Prep.	-	20	-	42	-	22	-	20	-	12	-	20
Private	6	6	8	30	2	58	5	44	2	16	6	40

⁽¹⁾ Sleep not reported.

⁽²⁾ Man 6 worked approximately 3 hours on microbiology at a table in the aisle by his bunk in the private area.

Figure 2-14. Overview Crew Time Distribution, Day 1

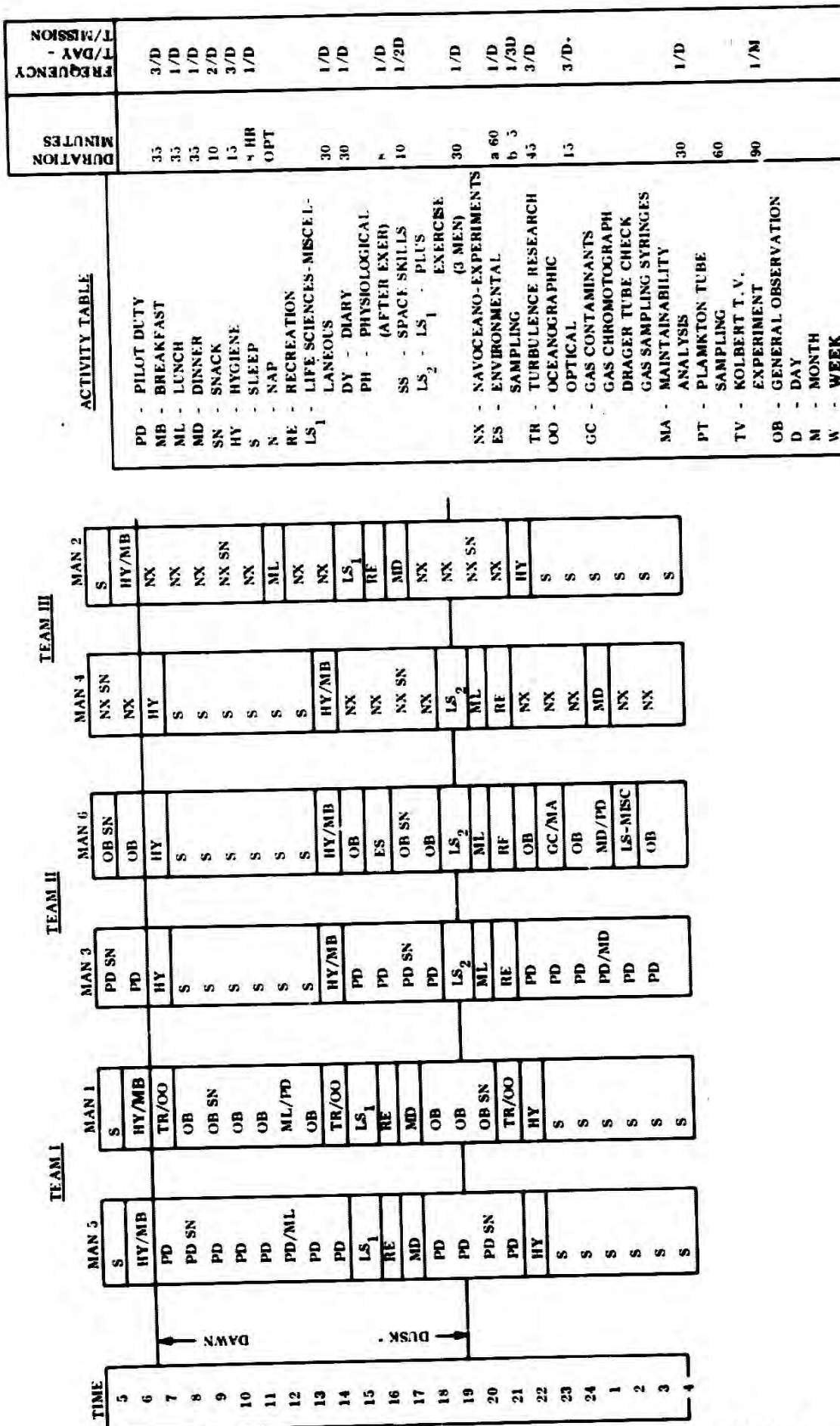

Figure 2-15. Typical Planned Crew Time Lines

- Planned activity for each location was generally dependent on the design of the vehicle.
- Work was scheduled to afford each crew man appropriate work and relaxation.

Planned and actual crew time lines are presented for Man 1 for Days 1, 6, 8, and 25 are illustrated in Figure 2-16. Each crew member's time line is discussed in Appendix B. From the time-line comparisons in Figure 2-16 it is apparent that Man 1 did not follow the crew time line. The following factors account for these deviations.

- Targets of opportunity occurred during the early mission phase.
- He favored a normal day/night cycle.
- Two pilots on board were prepared to take over his share of the pilot work load, until the mid-point in the mission. The two pilots anticipated that pilot relief from Man 1 would be minimal during the early mission phase.

Planned and actual activity summary of Man 1 in hours is:

Location	Planned Hours	Actual Hours			
		Day 1	6	8	25
Scientific	0	0	1	0	0
Private	9	9	11	9	11
Command/Control	2	0	0	0	7
Galley	3	0	2	1	3
Ward Room	10	15	10	14	3

For example, the pre-mission planning anticipated that this man would spend 10 hours in the ward room and he actually spent 15 hours in the ward room during the first mission day.

The comparison of planned and actual time lines indicates the need to allow for deviation from planned activities. If flexibility is not provided, a deviation by one crew member creates an increased work load for another. In the GSDM there were several departures which illustrated this point. All were necessary, but nevertheless they interfered with the activities of those not directly involved.

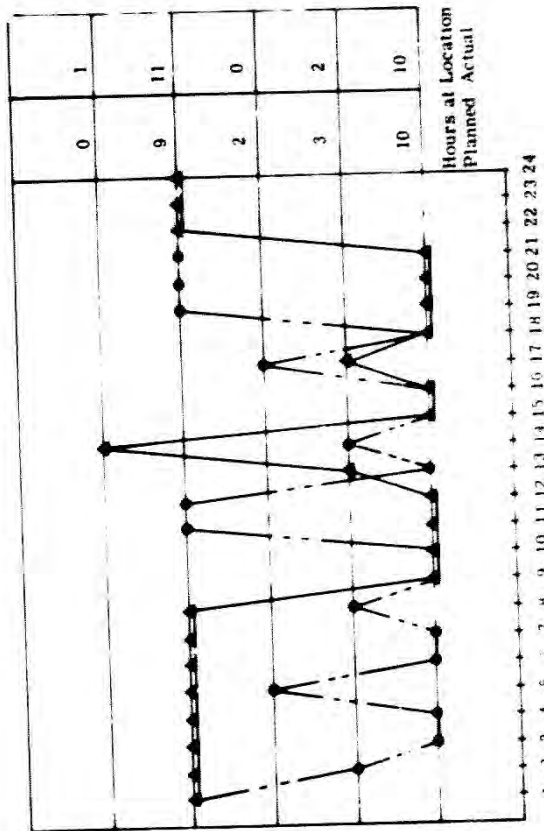

PLANNED LOCATION
ACTUAL LOCATION

Day 1

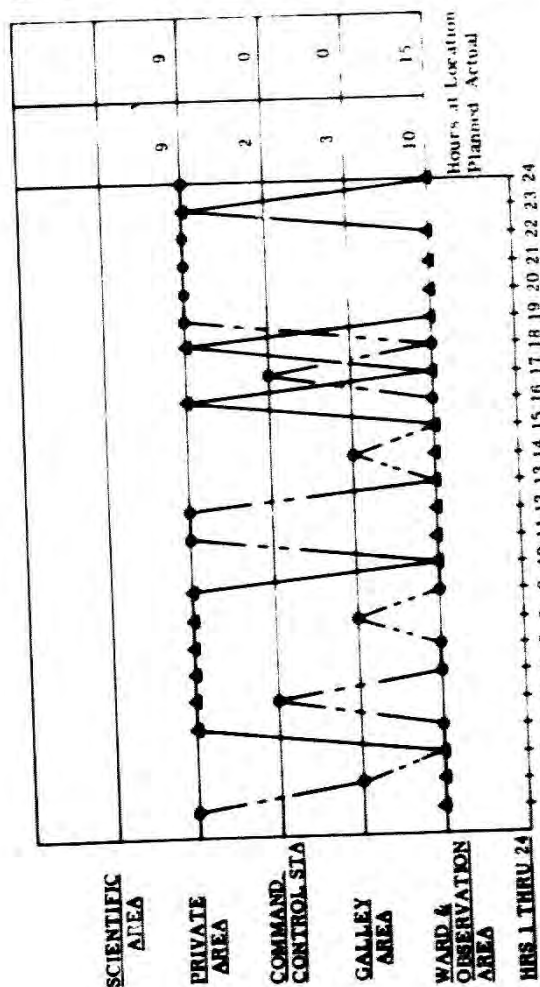

PLANNED LOCATION
ACTUAL LOCATION

Day 6

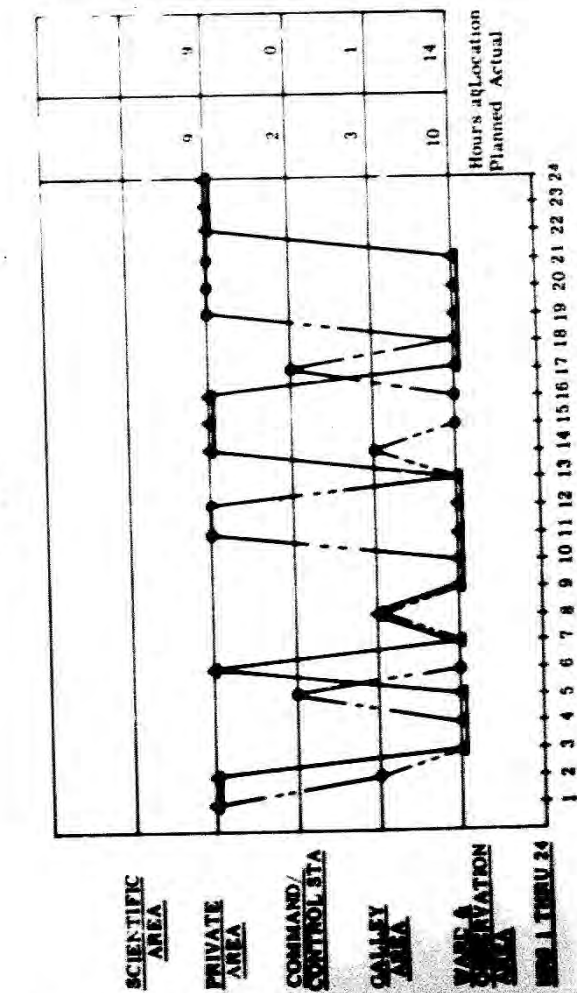

PLANNED LOCATION
ACTUAL LOCATION

Day 8

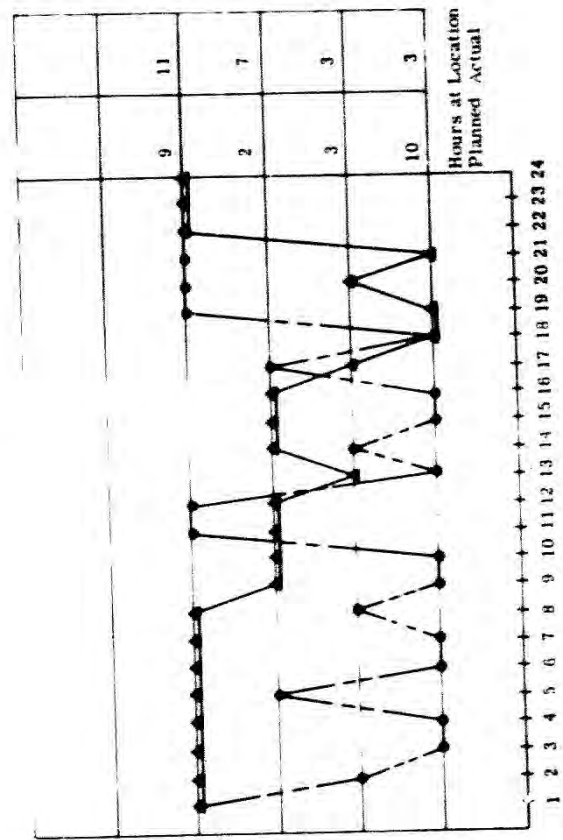

PLANNED LOCATION
ACTUAL LOCATION

Day 25

Figure 2-16. Actual versus Planned Time Line, Man 1, Day 1, 6, 8, 25

A target of opportunity is an understandable reason for not conforming to the crew time line; another could be an unscheduled uncontrolled maintenance activity. These take priority over routine activities. In addition crew members have different fatigue levels and cannot always sleep as scheduled. Use of the same area for work and recreation causes many conflicts, particularly when targets of opportunity are encountered. This situation causes one crew member to interfere with the other's work/recreation activity. The off-duty crew member is forced to leave the area, or join in the sudden activity caused by the target of opportunity.

The habitability observations provided insight into the "real mission" crew activity. However, the use of cameras should be refined for more sensitive observations.

2.6 HABITABILITY PLANNING CONSIDERATIONS

The techniques used in this analysis can be utilized in developing criteria for more habitable interior arrangements in spacecraft. After designing an interior arrangement, a Level 1 prediction analysis can be developed to determine how the crew will use the vehicle in an ideal case. The crew follows planned time lines, and their activity is not affected by unscheduled events (e.g. targets of opportunity). These data can be incorporated in a computer program to give each crew man's scheduled position and activity in the vehicle.

From the basic program, a more comprehensive effort or Level 2 prediction analysis could be developed. This would include targets of opportunity and other deviations from the planned time line. The program would estimate how the disruptions in scientific, piloting, recreation and rest activity affect mission success. These variances could apply plus and minus points to a mission success index depending on what activities are affected at that time. Through the development of this type of prediction technique, the designer could determine where the interior design contributes to or detracts from mission success and habitability.

Prediction techniques of this type can fill the void created by the lack of experience in habitability design. After the interior designs have been iterated in this type of program,

the selected interior arrangement can be installed and tested under mission conditions in a Space Station Analog. Mission data can be the means for testing habitability prediction techniques to increase confidence levels in making habitability decisions. The fundamentals of habitability prediction techniques were partially developed during the GSDM and a continuing effort is necessary to fully develop spacecraft habitability design guidelines.

SECTION 3

ENVIRONMENTAL ANALYSIS

BEN FRANKLIN has a free air volume sufficient for six men to breathe for 6 hours without removing CO₂ or replacing O₂. Therefore, the submersible can be used for a dive of less than 6 hours and not require a life support system. On missions of up to 5-day duration, the crew need only be concerned about the percentage of oxygen, carbon dioxide and nitrogen for atmospheric control and keeping the submersible at a comfortable temperature and humidity. On longer missions the crew is faced with the insidious buildup of trace contaminants, many of which are hazardous at levels under 50 parts per million. (The crew is the generator for most of the contaminants shown in Figure 3-1.)

The crew was instructed to monitor and control the equipment so as to:

- **Insure a proper balance of atmospheric gases**
- **Aid in maintaining a comfortable temperature and humidity**
- **Monitor trace contaminants and take necessary action to control the quantity of contaminants.**
- **Evaluate the operation of a gas chromatograph and compare its data to the ship monitoring instruments**
- **Collect air samples during the mission for post mission analysis**

The use of the gas chromatograph and drager tubes during the mission is illustrated in Figure 3-2. A summary of environmental measurements is presented in Figure 3-3.

3.1 INSTRUMENTS

The environmental measurements have been grouped into four categories:

- **Basic Atmospheric Constituents**
- **Crew Comfort**

**SOURCES AND PRODUCTION RATES OF VOLATILE METABOLICALLY
GENERATED CONTAMINANTS**

Contaminant	Source	Average Daily Prod Rate/ Man Day-In P. P. M	M. A. C. - PPM	
			90 Day	24 Hours
Carbon Monoxide	Respired Air	9.6	25	200
Methane	Flatus	108	13000 (3)	13000
Ammonia	*Feces	}	25	50
	*Feces			
	*Urine			
	Perspiration			
Hydrogen Sulfide	*Saliva	78		
	Flatus	0.0042	(1)	(1)
Hydrogen	*Feces			
	Flatus	345	4% (2)	4%(2)
Acetone Bodies	*Urine	--	--	--
Volatile Acids	*Feces	6.66	--	--
	Perspiration			
	*Urine			

- (1) *Only a minor portion from these sources reaches the breathable environment.
- (2) Lower combustion limit of H₂ in air.
- (3) Set at approximately 1/4 lower explosive limits of 5.3%.

M. A. C. - Maximum Allowable Concentration

1) P. P. M. - Parts Per Million

**Figure 3-1. Sources and Production Rates of Volatile Metabolically
Generated Contaminants**

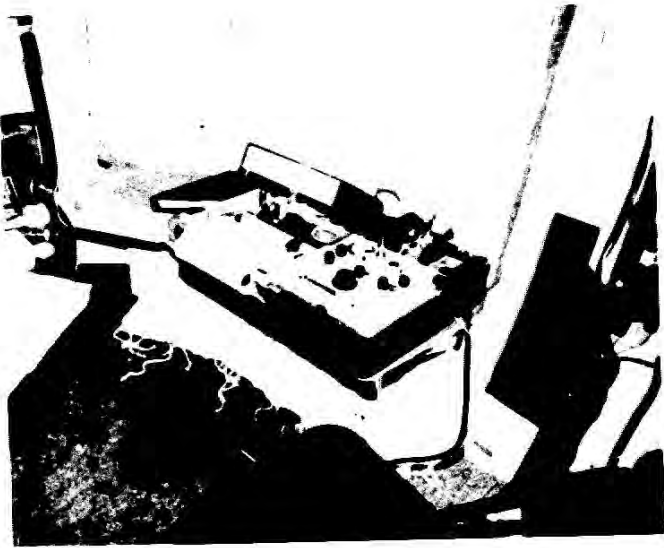

a. Gas Chromatograph Operation



b. Drager Tube Operation

Figure 3-2. Environmental Analysis

ENVIRONMENTAL MEASUREMENTS

item	Reading	Freq	Instrument	Operation	Power Watts
Oxygen	Percent	2 hrs	Teledyne O ₂ Sensor	Continuous	0
Carbon Dioxide	Percent	4 hrs	Fyrite CO ₂ Analyzer	Manual	0
Pressure	Atmosphere	4 hrs	Pressure Gage	Continuous	0
Temperature					
Internal	° Farenheit	4 hrs	Abeon-Gage	Continuous	0
External	° Centigrade	4 hrs	Trub, Tauber, Cie Gage	Continuous	0
Relative Humidity	Percent	4 hrs	Abeon-Gage	Continuous	0
Trace Contaminants					
° Metabolic	*PPM	24 hrs	Drager Gas Detector Tubes	Manual	0
° Other	*PPM	1 wk	Drager Gas Detector Tubes	Manual	0
Oxygen	} *PPM	72 hrs	UNICO-PGC-Series/O Gas Chromatograph	Manual	200(1 hr)
Nitrogen					
Carbon Dioxide					
Carbon Monoxide					
Methane					
Hydrogen Sulfide					
Hydrogen					

* Parts per million

Figure 3-3. Environmental Measurements

- Trace Contaminant
- Equipment Evaluation

The instruments used for measuring each of the categories are described in Appendix C.

3.2 PROCEDURES

Atmospheric temperature, humidity, pressure and carbon dioxide measurements were recorded every four hours. Oxygen was recorded every two hours. Upper limits were set at 1.5 percent for CO₂ and 23 percent for O₂. The lower limit for O₂ was set at 19 percent. Temperature and humidity varied with sea water temperature. To increase the temperature, the submersible ascended to warm waters, and vice versa. To decrease humidity, silica gel was dispersed throughout the vehicle. Atmospheric pressure limits were plus or minus 2 psi due to normal variations in temperature and gaseous constituents. Larger variations were subject to investigation and were usually due to air leakage from the pneumatic system.

Trace contaminants were checked daily and weekly using Drager tubes. The gas chromatograph was operated periodically (usually every three days) and the data were compared to data from the ship instruments i. e. Teledyne, Fyrite, etc.

Atmospheric samples were collected in 25 milliliter syringes for post mission analysis. The air samples were taken every 3 days at various locations throughout the submersible.

3.3 PRE-MISSION TRAINING AND EXPERIENCE

In December 1968, a 3-day closed boat test provided training for three members of the GSDM crew. During the shakedown test of the life support system, measurements were made with all of the ships instruments except for the gas chromatograph. Atmosphere samples were sent to Bethpage for chromatographic analysis. The results of the test were within design limits and no life support system changes were necessary. As the program proceeded into its sea trial phase the crew was able to gain further experience in operation of the ship's instruments.

For the two months prior to the mission, one member of the crew was given an intensive training program that included operation of all the environmental monitoring instruments.

3.4 MISSION DATA

The following paragraphs present data taken during the GSDM.

3.4.1 Basic Atmospheric Constituents

3.4.1.1 Oxygen

Figure 3-4 presents a plot of oxygen level throughout the mission. It shows that the level remained between 19.5 and 22 percent. All adjustments were made manually with the flow meter. Nine corrections were made in the first 12 days during which O₂ levels varied 2.5 percent, ranging between 19.5 and 22 percent. In the remaining 18 days only 3 adjustments were made and the O₂ level varied 1.5 percent, holding between 19.5 and 21 percent. Finer control could have been obtained if it had been desired. The automatic control, originally part of the system, was disconnected prior to the mission to eliminate the need for an inverter and thus conserve electrical energy.

The data presented were taken with the Teledyne oxygen detector.

3.4.1.2 Carbon Dioxide

Figure 3-4 also shows a plot of CO₂ level using data obtained with the Fyrite CO₂ indicator only. As shown, the CO₂ level was maintained between 0.4 and 1.5 percent. The anticipated CO₂ buildup rate would have required that the LiOH panels be changed every 2.5 days; however, the actual need was closer to every 3 days. Analysis, based on the amount of CO₂ picked up by the panels, yielded a CO₂ generation rate of approximately 1.7 pounds per man day, which was fairly consistent with the crew's activity levels during the mission as well as the amount of O₂ consumed.

3.4.2 Atmospheric Pressure

Atmospheric pressure ranged between a low of 1.01 atmospheres at the start of the mission to a high of 1.12 atmospheres (Figure 3-4). The highs occurred twice, once when the boat surfaced and was under tow, and again at the end of the mission. The net variation of 0.11 atmospheres or 1.6 psi was within operational levels. After the first day, a slight air leak in the pressure regulator from the variable ballast tanks (VBT) was detected and

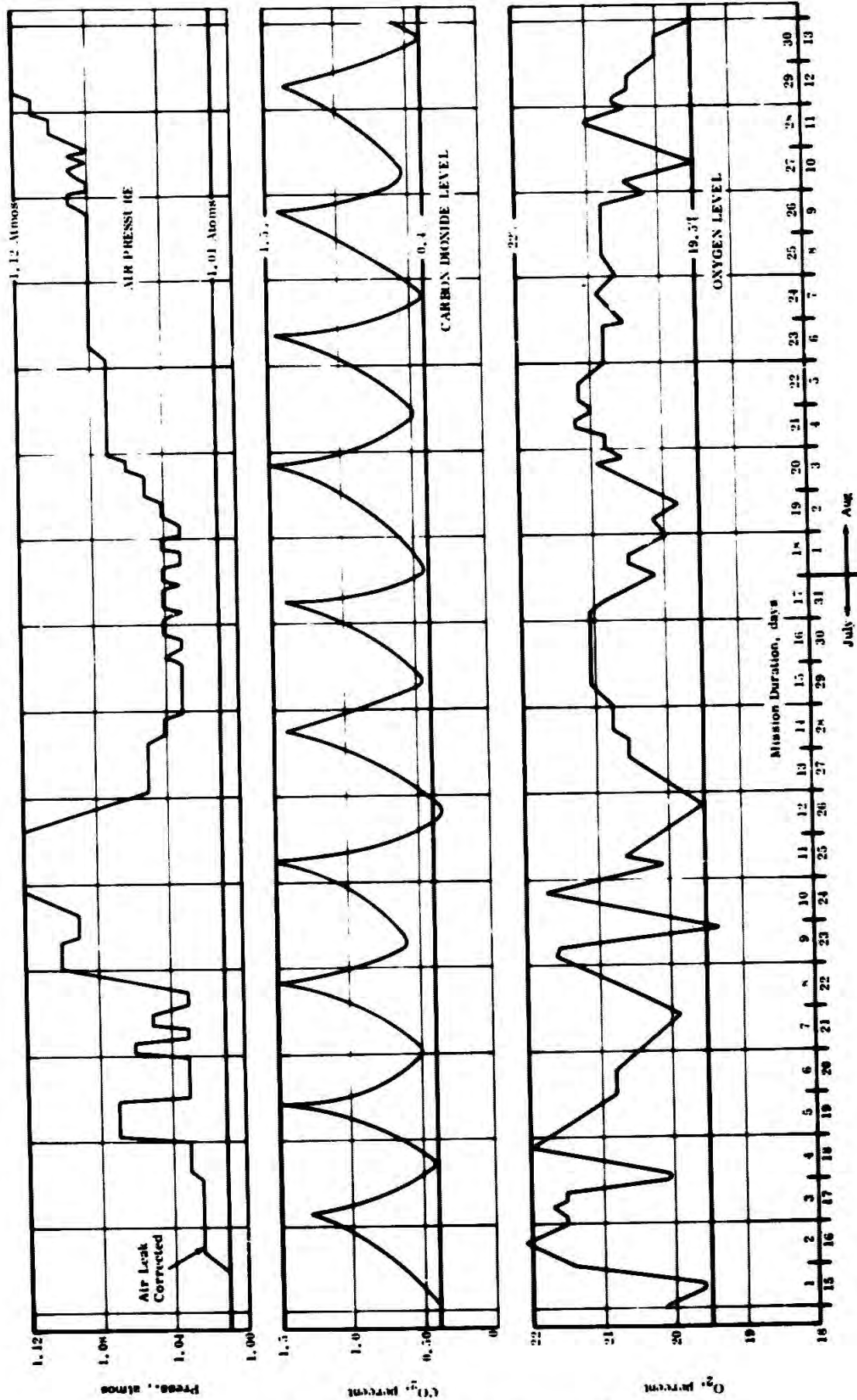

Figure 3-4. Log of Air Pressure, CO₂ and O₂

corrected. Cabin pressure increased to 1.025 atmospheres. The following series of pressure variations were due to temperature changes. As previously pointed out the pressure increased to its highest when the boat heated up while on the surface under tow. After re-submerging the vessel cooled down and the pressure remained between 1.03 and 1.04. The variations at this point are so slight (0.01) that they can be explained as an error in reading the pressure gage. The rise in pressure from 1.04 on Day 20 to 1.12 on Day 30 was caused by the recurrence of the regulator air leak into the boat during VBT operation.

3.4.3 Crew Comfort

3.4.3.1 Temperature

Figure 3-5a presents plots of sea water and cabin temperatures. Except for those relatively short intervals during which the vessel bottom sat or made deep dives, sea water temperatures varied between 62 and 65° F. Corresponding cabin temperatures were 66 and 68° F. This period, which represented more than half of the mission, was quite comfortable for the crew. On the deep dives sea water temperatures went as low as 41° F, cabin temperatures went down to the mid fifties and the vessel became uncomfortable. There were also two instances when the boat became hot, the first occurring while the vessel was trying to power itself back into the Gulf Stream, and the second time when the vessel was on the surface under tow. Temperatures rose to 73 and 84° F respectively.

The vessel reached equilibrium after approximately 6 hours with cabin temperatures running 3.5° F above sea water temperatures. This temperature difference was less than expected. In previous dives, a difference of 5 to 7° F was experienced. Explanations for this deviation are:

- Lower internal electrical power consumption during the drift mission compared to previous dives.
- Activity level of the crew was slightly lower than on previous dives.

Temperature control of BEN FRANKLIN by passive means was possible because of the warm temperatures of the Gulf Stream. Operation of the vessel in colder waters requires insulating the boat and use of a heat source. Work is now under way to come up with a system for making BEN FRANKLIN operational in all sea water temperatures.

3.4.3.2 Humidity

Due to power limitations, silica gel was utilized for humidity control. With 3600 pounds stowed aboard for the drift mission, roughly 2400 pounds were used. The mission started with approximately 600 pounds exposed; additional silica gel was exposed as needed. Figure 3-5b shows the history of the relative humidity maintained between 70% and 80% except for a few short intervals. Relative humidity appears to have fluctuated randomly. In general, whenever the vessel cooled down, the humidity rose and whenever the temperature increased, the humidity decreased. There also appears to be a correlation between relative humidity and Carbon Dioxide level. The lows for the CO_2 tend to correspond to a decrease in relative humidity. This may be explained by an immediate pickup of moisture by freshly exposed LiOH panels.

In the post mission debriefing, the crew stated that humidity levels throughout the mission were comfortable.

3.4.4 Contaminant Removal

Throughout the mission, contaminants were checked both on a daily and a weekly basis. The most probable metabolic contaminants were looked for daily with the Drager gas detector tubes. These gases included NH_3 , CO , H_2S , NO_2 , and SO_2 . Twenty-eight other items were looked for on a weekly basis also using Drager tubes. (The use of the Drager tubes is illustrated in Figure 3-2a.) After approximately 5 days, carbon monoxide started to show up (8 ppm). A detailed history of the CO situation was maintained throughout the mission. The CO level continued to rise and when it reached 20 ppm the active contaminant removal system was operated with no effect. The CO level continued to build up and by mission end was 40 ppm. The CO level projected for the 6-man 30-day mission was approximately 34 ppm. In the first full contaminant check (Day 8) a trace (0.2 ppm) of ammonia and 200 ppm of acetone were detected. Periodic rechecking of these two items throughout the mission showed very little change. The ammonia could also represent an amine and the acetone a ketone or an aldehyde.

Nine atmosphere samples were taken at approximately 3-day intervals for post-mission analysis. The results of the analysis indicated that there was leakage from some and possibly all of the sample containers. Further testing of the syringes confirmed this

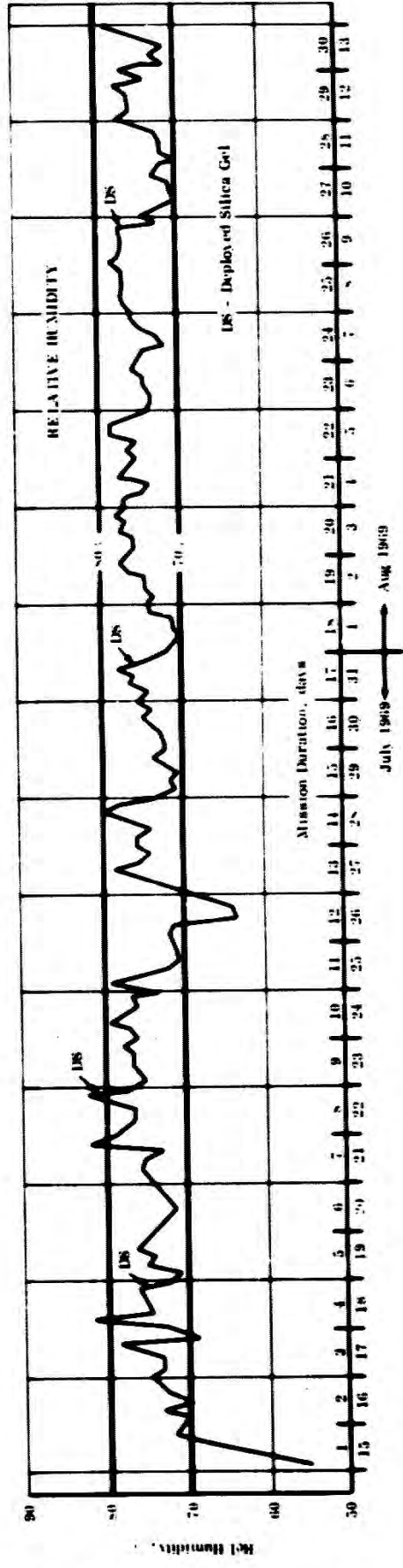
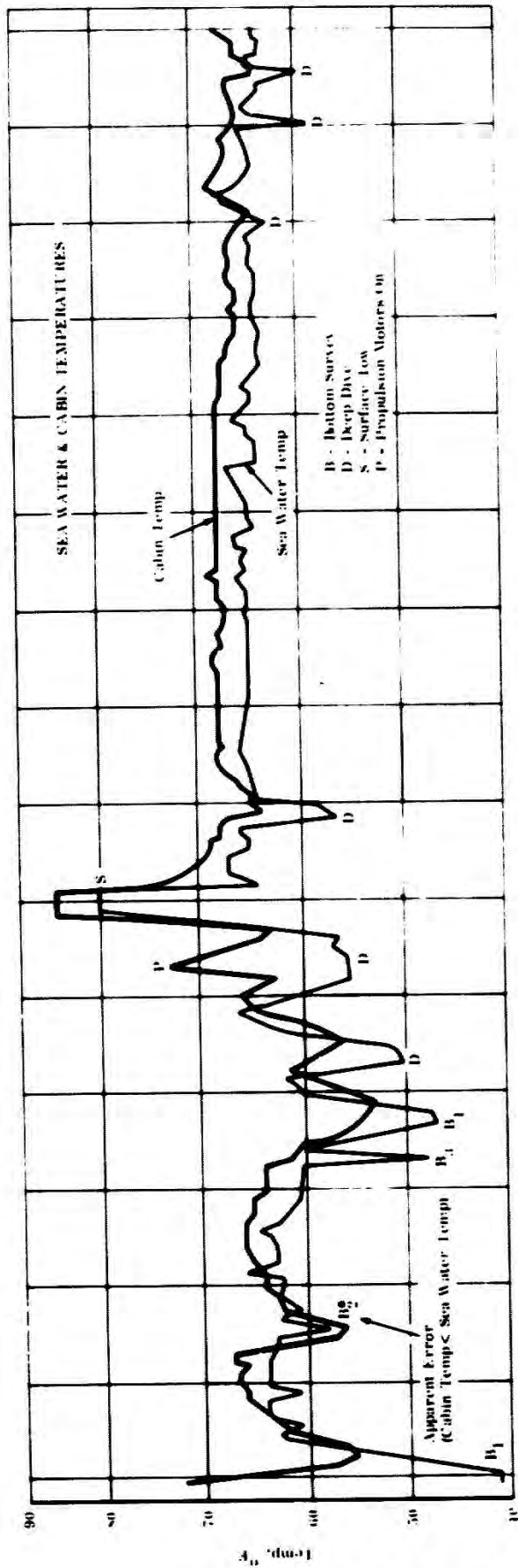

Figure 3-5. Log of Temperature and Relative Humidity

theory. Though the quantitative data are not valid measures of the onboard environment, results did indicate the presence of methane and hydrogen. The presence of methane was also indicated by the chromatograph.

3.4.5 Equipment Evaluation

In the past, doubts were expressed as to the feasibility of employing gas chromatographs as an environmental monitor within a closed system having a high CO_2 level and high relative humidity. Specifically questioned was the effect of high CO_2 and humidity on poisoning the columns. Poisoned columns cause loss of resolution and retention. Results of the mission show that with the limited operation (1 hour every other day) none of the above occurred. Post-mission analysis of the unit showed no variation with premission checks. Typical pre- and post- mission analyses are presented in Figures 3-6a and b. (Operation of the gas chromatograph is shown in Figure 3-2a.)

Mission results indicate the need for column and detector temperature control to minimize baseline drift, extensive pre-mission training for the operator, increased sensitivity to CO and H_2S , and incorporation of a column to measure NH_3 . A sample of the data from the mission illustrates the drift problem (see Figure 3-6c).

The crew was able to monitor and control their environment with a high degree of confidence without any evidence of psycho-physiological effect. This is based on the data in Vol. 2. In a future Space Station, crews should have the means to monitor and control their environment in terms of contaminants and other atmospheric constituents.

The use of the Drager tubes to easily identify trace contaminants in the atmosphere could be useful in future Space Stations, but the gas chromatograph requires design improvement.

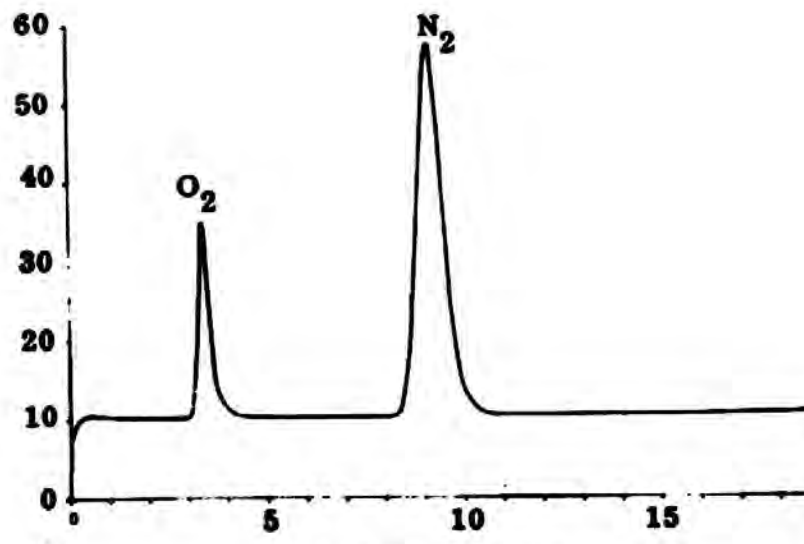

a. Pre-mission

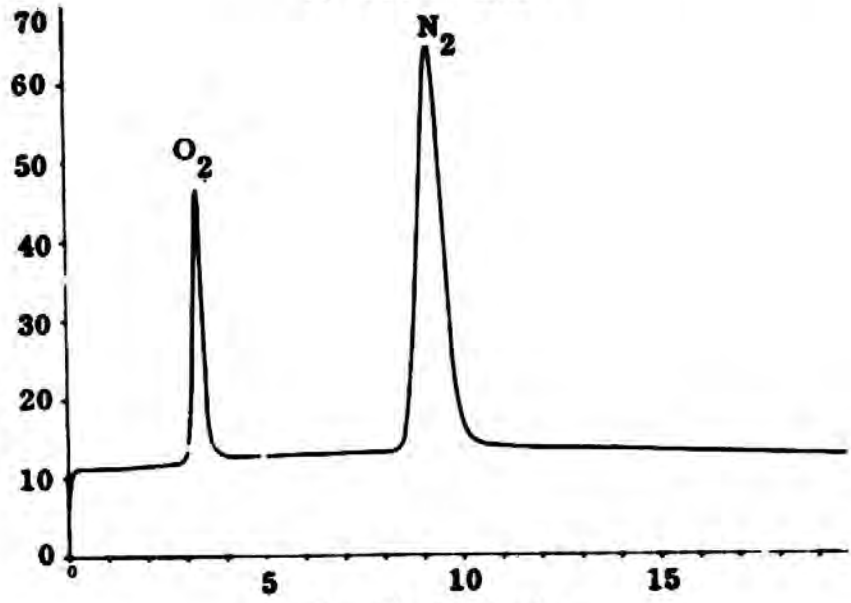

b. Post-Mission

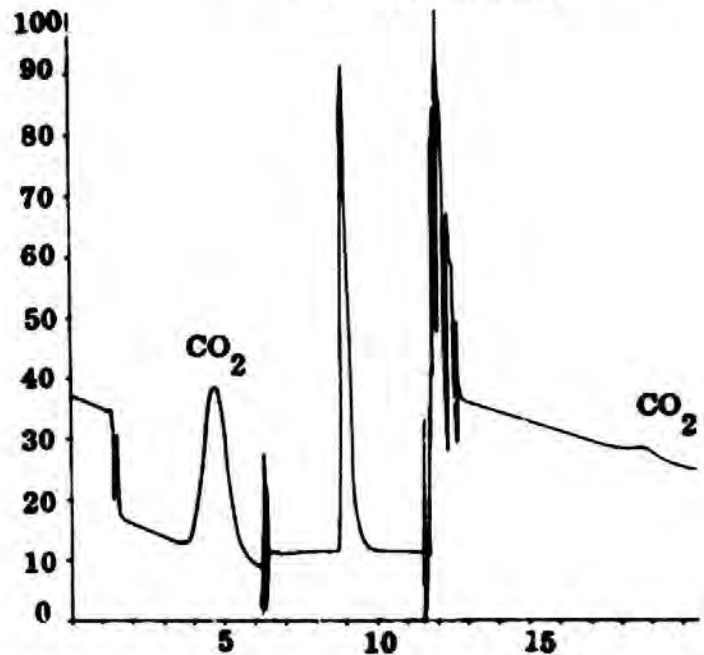

c. Typical Mission

Figure 3-6. Results of Gas Analysis Using the Gas Chromatograph

SECTION 4
FOOD MANAGEMENT

4.1 Basic requirements

- Long storage life
- Minimum storage volume
- Simplicity of preparation
- Minimum power - preparation, preservation
- Wide selection
- No open flames

4.2 Food System

Foods could not be refrigerated because of the large energy drain. Freeze dried and canned foods presented a limited menu, but satisfied storage, preparation, and refuse problems. Cooking could not be tolerated since open flames were not allowed and use of electrical power was restricted. Foods considered were:

- Astronaut type (squeeze tube, bite size, etc.)
- Army rations (precooked thermally sterilized)
- Freeze dried (combination of commercial and military types)

With the aid of Natick Labs and after a series of tests climaxed by the 3-day, closed-boat test, it was decided to use freeze dried food supplemented with some off-the-shelf canned and dried foods. Stow-A-Way Products of Massachusetts, a retailer of camping supplies, working with Grumman, developed a balanced diet and menu for the mission (Appendix D).

The food supplied by Stow-A-Way was packaged in sealed plastic bags, each of which contained daily rations for two men. Each large bag contained four smaller sealed packets holding food for breakfast, lunch, supper, and snack. (The galley area is shown with the food packages in Figure 4-1.) Five different menus, in packages, numbered 1 through 5,

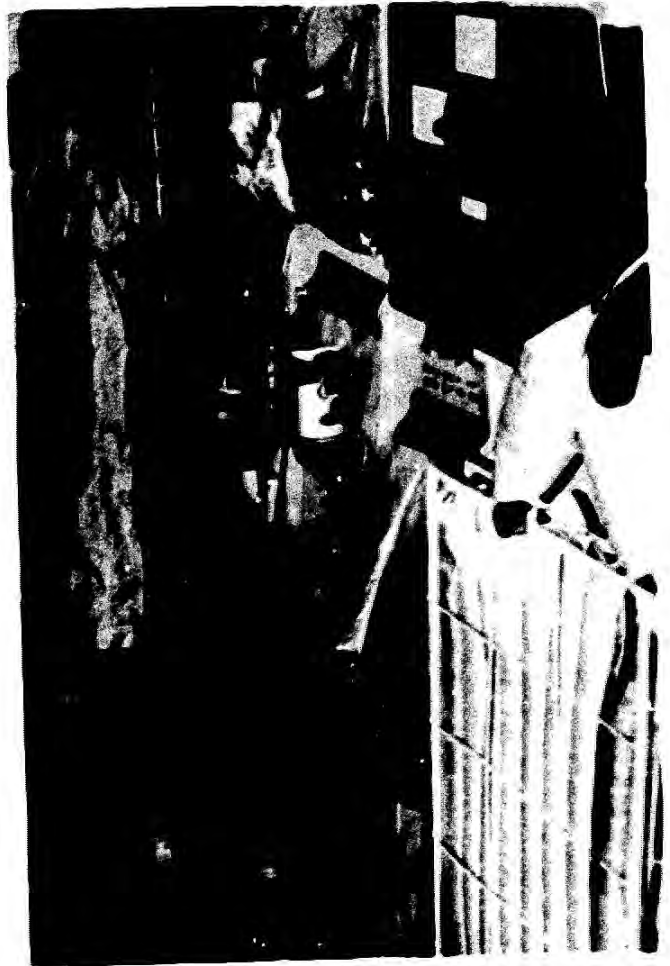

Figure 4-1. Galley Area - Food Preparation

contained roughly 3,000 calories per man. Anticipated daily requirement was 2,500 calories per man. This type of packaging minimized storage space and refuse, and eliminated the need for selecting each item of the meal. Refuse from each meal was sprayed with a anti-microbial solution and stowed in the meal packet, which, in turn, was stowed in the larger daily food packets. Teflon coated plates, cups and utensils were provided to facilitate clean up. Dishes and utensils were cleaned in a special reusable sterilizing solution containing microguard.

Due to the limitation of space, the amount of food stores was kept to a minimum. There was enough food for a 30 day mission plus a 12 day contingency. This included 85 packages or 170 meals and 60 pounds of a special health food (dried fruits and nuts mixture for two of the crew members. Lastly, a carton of selected freeze dried salads and juices was taken along with extra sugars, coffee, tea, powdered milk, etc.

4.3 Crew Acceptance

Acceptance of the food by the crew was varied. Many items were not enjoyed because the water was not hot enough to prepare the food properly and the cold water had an iodine taste. Preparation of some foods was more difficult than others. A few items were totally rejected on the basis of flavor or consistency (biscuits, milk shakes, chocolate bars). The overall consumption by the crew was less than planned (about 2300 calories per day) and four of the six crew members lost an average 11 pounds each while two showed no change. Of the four who lost weight, one used the mission as an opportunity to diet and two others drew heavily from their personal cache of dried fruit and nuts, using freeze dried foods for supper only.

Subjective data from the crew logs and debriefing sessions reveal that individual food-ratings varied from good to bad based on individual crew preferences. Crew complaints about food increased with time, as illustrated in Figure 4. 2.

Man has food preferences which must be satisfied when entering inner or outer space for long durations. The problems of food handling, preparation, taste, etc. during the GSDM are analogous to those of future space station which will have limited food management programs. These should include variety, simple food preparation, adequate galley space and easy methods for clean-up. The energy budget should include power for heating the food. The crew should have the opportunity to eat the food for long periods (approximately one month) in the pre-mission phase before final agreement on the menu(s) for the mission.

To increase confidence in future food management systems, it behooves the planners to test these systems with similar crews in a confined/isolated long duration test programs. By working and living with the proposed food management systems, the real problems will be identified for refinement before incorporating into the space stations.

SYMBOL
 ●
 ○

ITEM
 FOOD
 HOT WATER

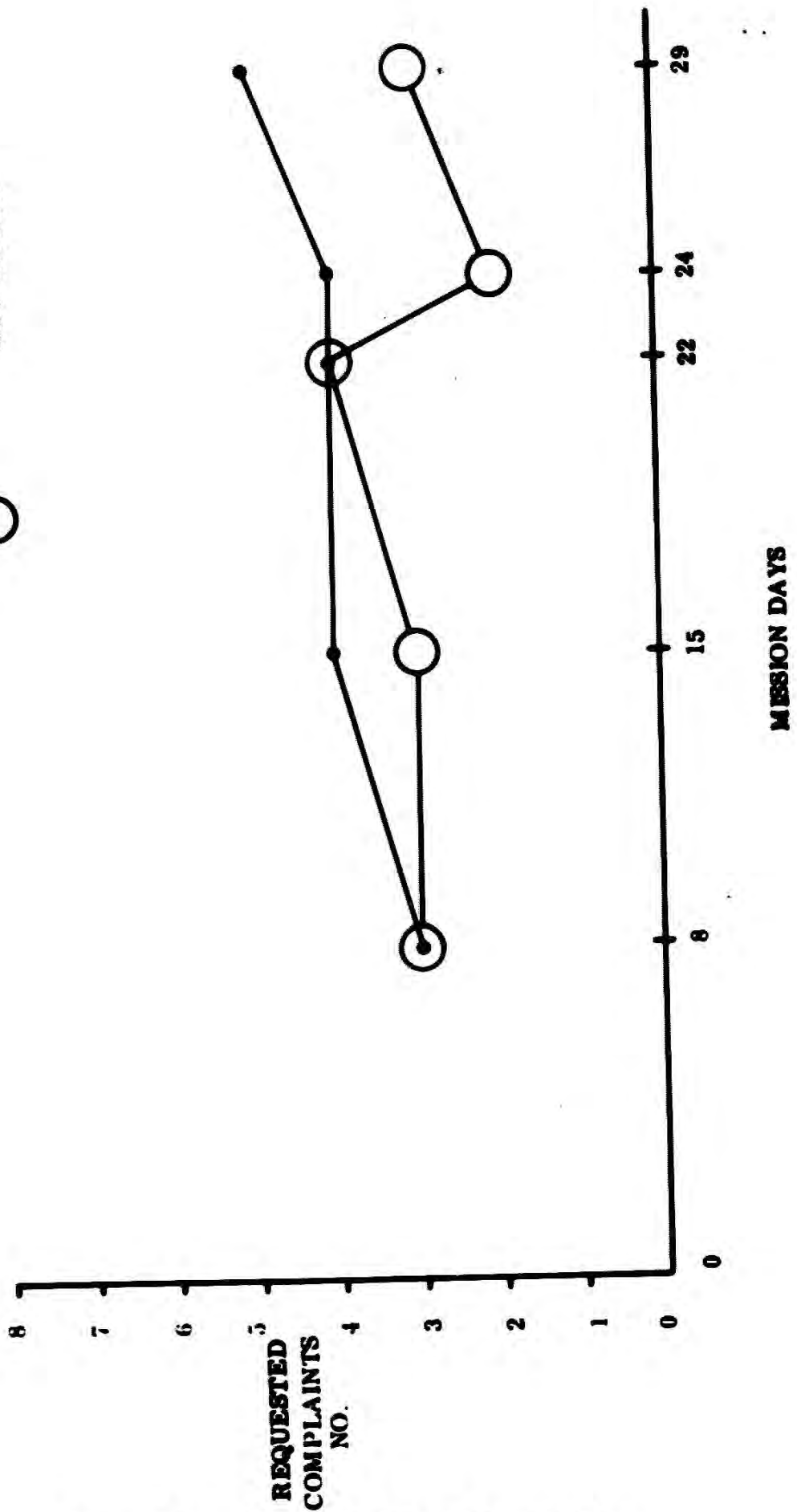

Figure 4-2. Food and Hot Water Complaints

SECTION 5

WATER MANAGEMENT

The BEN FRANKLIN carried approximately 4400 pounds of potable water, 2900 pounds of cold water, and 1500 pounds of hot water.

Cold water was stored in four saddle tanks located between pressure hull ring stiffeners, three of which held 95 gallons each and the fourth 60 gallons. The tanks were constructed so that the hull served as one of the tank faces. Figure 5-1 shows the location of the tanks.

Hot water was stored in four vacuum-jacketed 50 gallon tanks. The tanks were designed so they could be heated to 210^oF (using shore power) and maintain a temperature above 160^oF for four weeks (see Figure 5-2).

5.1 DISTRIBUTION

The potable water distribution system includes: three sinks, one in the galley with hot and cold water, one in the head with cold water only, and one in the shower area with blended hot and cold water, plus a shower with blended hot and cold water. All drains from all sinks and the shower empty into storage tank from which water is drawn for flushing the toilet (see Figure 5-3). All of the water, except for a reserve supply of 60 gallons in the smaller saddle tank, was to be consumed during the mission. To prevent contamination, the cold water was treated with iodine as part of a biological sterilization program (Volume IV). The amount of water consumed was recorded from meters installed in the cold water distribution lines and liquid level gages on the hot water tanks.

5.2 ALLOCATION

Figure 5-4 shows the water budget for the mission. Approximately 529 gallons of potable water were loaded on board the vessel at the start of the mission, 177 gallons of hot water and 352 gallons of cold water. At the end of the mission, approximately 57 gallons of the hot water and 112 gallons of cold water remained. Thus the amount of water consumed



Figure 5-1. The Ben Franklin

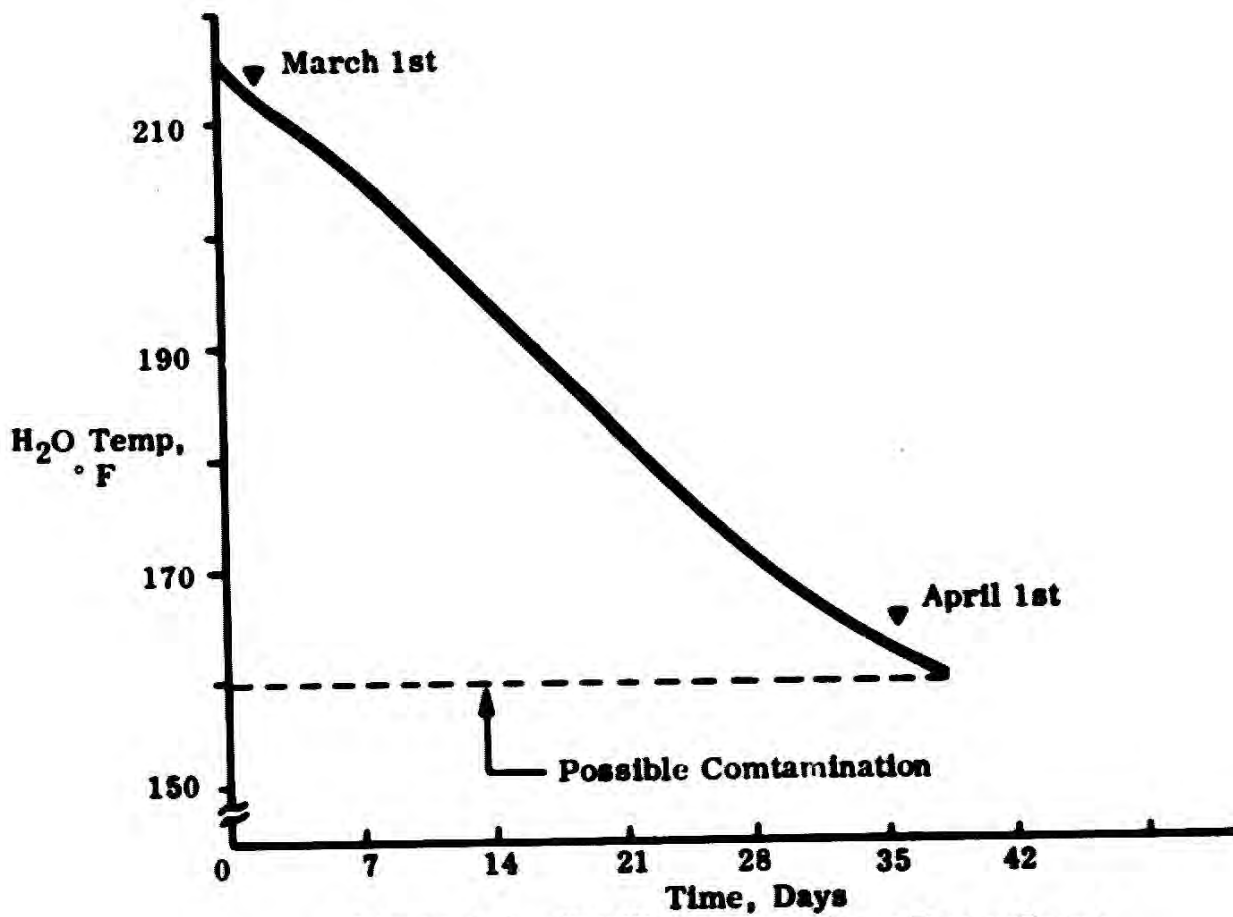

Figure 5-2. Hot Water Tank Temp Decay Curve

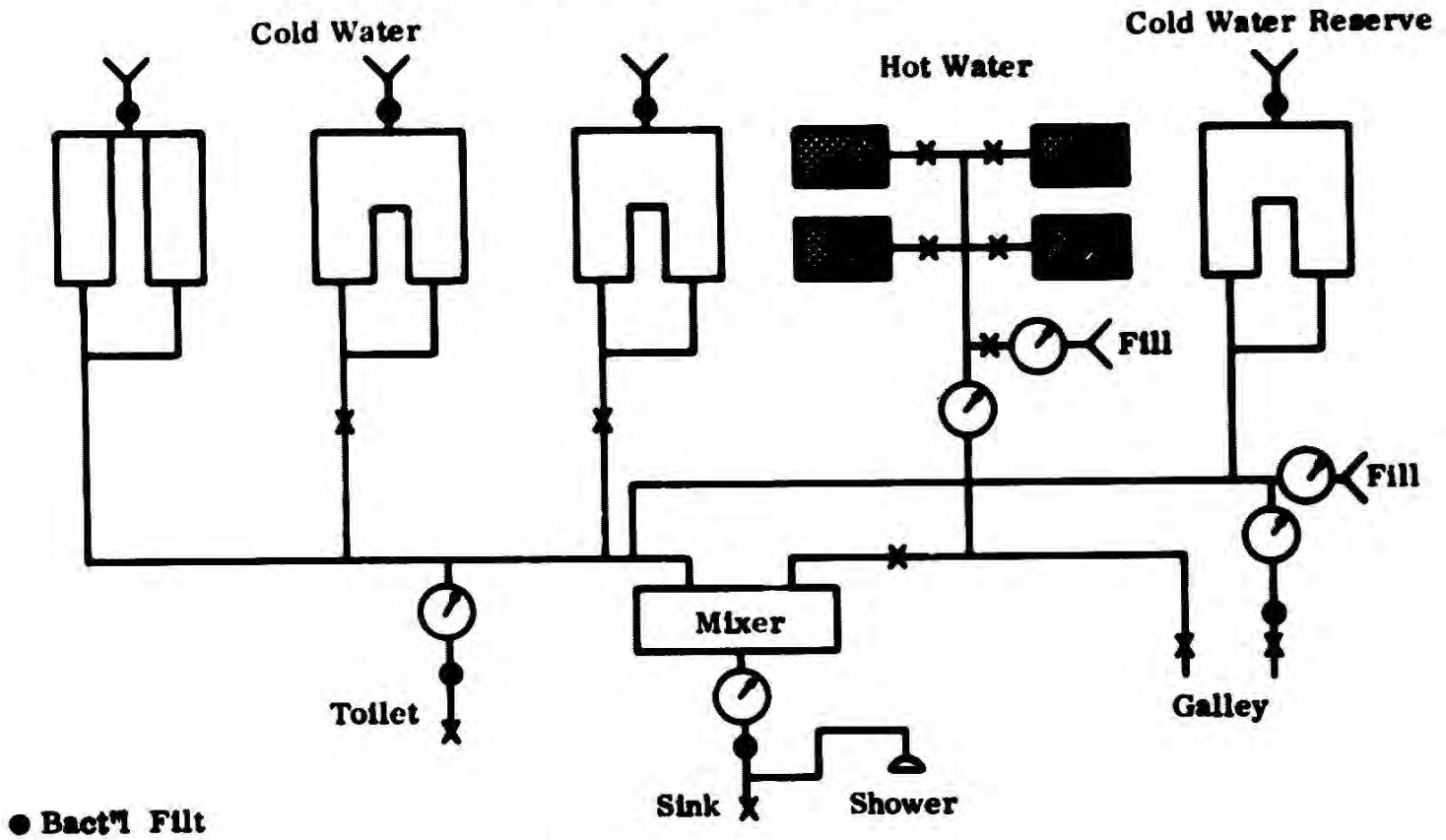

Figure 5-3. Water Management System

POTABLE WATER BUDGET

<u>Capacities</u>			
Cold Water	4 Tanks	352 gallons	2920 pounds
Hot Water	4 Tanks	<u>177 gallons</u>	<u>1470 pounds</u>
	Totals	529 gallons	4390 pounds

Allocated Use Rates

Hot Water	Food Preparation	5.4 lb./M Day
	Washing	<u>2.75 lb./M Day</u>
	Total	8.15 lb./M Day

Cold Water	Food Preparation	3.75 lb./M Day
	Washing	8.75 lb./M Day
	Clean Utensils	<u>1.33 lb./M Day</u>
	Total	13.83 lb./M Day

Figure 5-4. Potable Water Budget

by the crew was 240 gallons of cold water and 120 gallons of hot water. This averaged out to a daily use rate per man of 5.5 lbs. of hot water and 11 lbs. of cold water.

5.3 COLD WATER

Cold water was used primarily for personal hygiene and washing dishes (1 gal./day). Very little cold water was consumed in drink or food preparation primarily due to the cool temperature of the vessel and the repugnant taste of the iodine treated water. In fact, cold water consumption was so low that it was necessary to run it periodically just to keep the miniwaste tank from going dry. Biological measurements, taken throughout the mission as part of the program, are discussed in Volume IV.

5.4 HOT WATER

The mission was started with two of the four hot water tanks not working properly, i.e., the vacuum had been lost and the tanks cooled down rapidly. Water was drawn from one of the defective tanks for the first day, after which it was necessary to switch to the two good tanks. After approximately 20 to 22 days, the hot water was depleted and it became necessary to use electrical power to heat water for food preparation.

Not having sufficient hot water for food preparation and hot showers were two of the crew complaints. The number of recorded crew complaints throughout the mission are illustrated in Figure 4-2. The complaints fall off in the latter part of the mission because the crew used electrical energy to heat water for food preparation. The crew sponged their bodies with cold water in place of hot showers. The problems with the water management system emphasizes the needs of the crew. The crew was willing to endure 30 days without adequate water, but probably would not accept it for missions beyond 30 days.

Renewed emphasis is required to provide an uncontaminated water management system with adequate electrical energy for hot water. While chemicals and filtering are necessary means for sterilization of water, a backup approach should be provided which uses heat and mechanical devices requiring electrical energy.

SECTION 6

CLOTHING AND BEDDING

The selection of clothing and bedding for the mission was guided by the following considerations:

- Minimum storage facilities.
- No laundering facilities.
- Minimization of potential fire hazards.
- Crew Comfort.

6.1 CLOTHING

The clothing issue for each crew member consisted of:

- a) Ten changes of underwear (T-shirts, boxer shorts).
- b) Four changes of longjohns (Nomex)
- c) Ten changes of socks.
- d) Two pair of deck shoes.
- e) Three pair of walking shorts.
- f) Four pair of coveralls (Nomex).
- g) One cotton sweat shirt.
- h) One nylon windbreaker.

The clothing fabric was dacron and cotton except for the coveralls, longjohns and the windbreaker. The garments were treated with an anti-microbial agent (microguard). The underwear and socks were changed every third day during the mission; however, the crew desired a daily change, as noted during the debriefing sessions.

6.2 COVERALLS

Custom fitted jump suit coveralls were provided. The suits were made of "Nomex", a fire retardant fabric produced by DuPont and currently used by race car drivers. The material, which is a form of nylon, is lightweight and comfortable.

During the mission, as pointed out in the section on thermal control, the crew was uncomfortable during cold water operations. Only 72 hours were spent at temperatures below 60°F and of this only 24 was under 56°F. However, because of the crew's low activity level, the combination of a layer of cotton underwear, longjohns, a cotton sweatshirt, a Nomex jumpsuit and a nylon jacket failed to keep the crew comfortable. The crew complaints on clothing during the mission are illustrated in Figure 6-1. As a result of these complaints, special insulated undersuits will be procured and stored on board BEN FRANKLIN as normal operational gear to be used for cold water operations.

6.3 MATTRESSES

Special four-inch thick foam treated with a fire retardant finish was purchased from the B. F. Goodrich Corporation for use as mattresses. These were covered with "Nomex" covers. To our knowledge, these were the first fire retardant mattresses made. The crew complaints on the bunks are illustrated in Figure 6-2.

6.4 SHEETS, PILLOWCASES AND BLANKETS

An 80% dacron 20% cotton fabric was used for sheets and pillowcases. The bedding was pretreated with an antimicrobial agent that minimizes bacterial growth while the bedding is in use and during the time it is stored after use. Bedding was changed once a week. Two sheets, a pillowcase, and a cotton bath towel were packed in a double sealed plastic bag that also served as a storage container for the used bedding. Four sets were provided for each man. A high dacron/low cotton fabric is recommended for use on any boat. The fabric has excellent washing characteristics, and is slightly water repellent. Two lightweight dacron cotton blankets were provided for each bunk.

Clothing and bedding problems during the GSDM emphasize the need of intensive investigation and testing before long duration space station missions. The type of garment, its design, flexibility, general use, and marking for easy photographic identification are some of the areas requiring investigation.

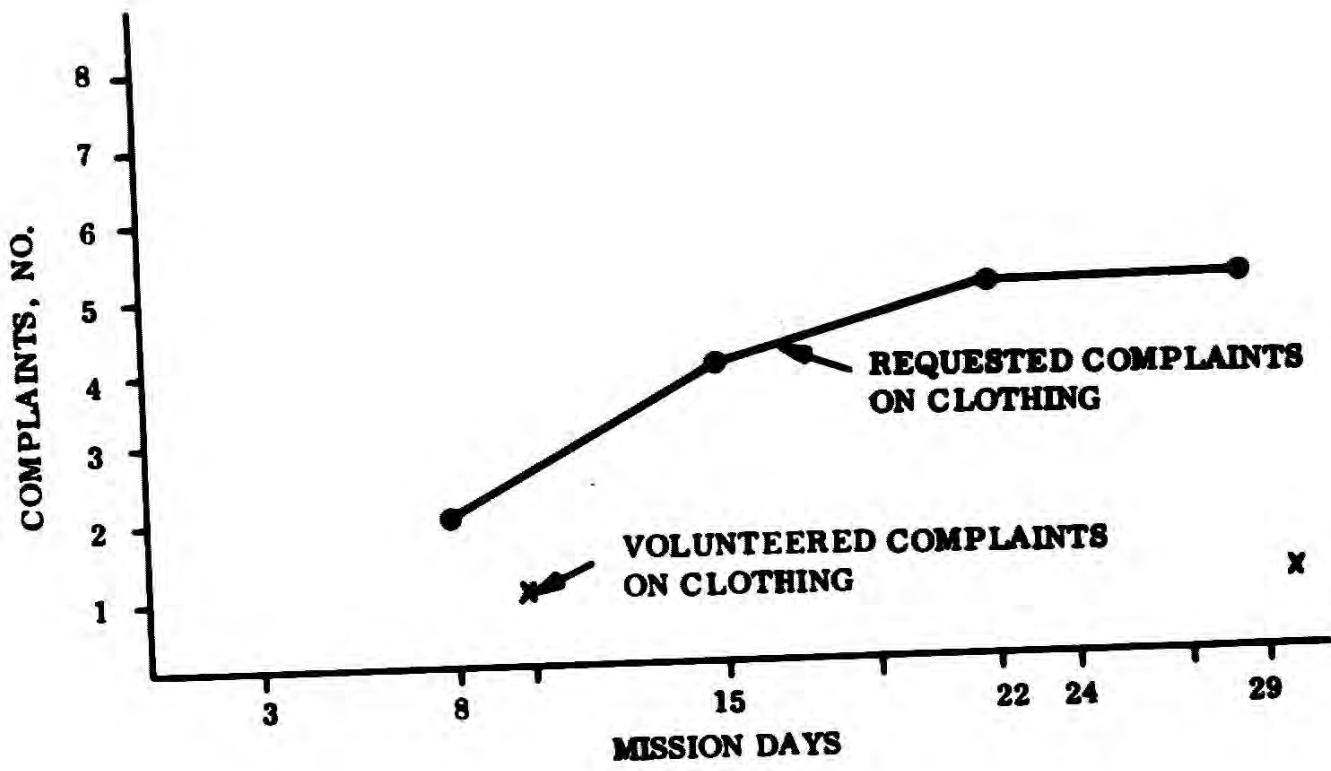

Figure 6-1. Clothing Complaints

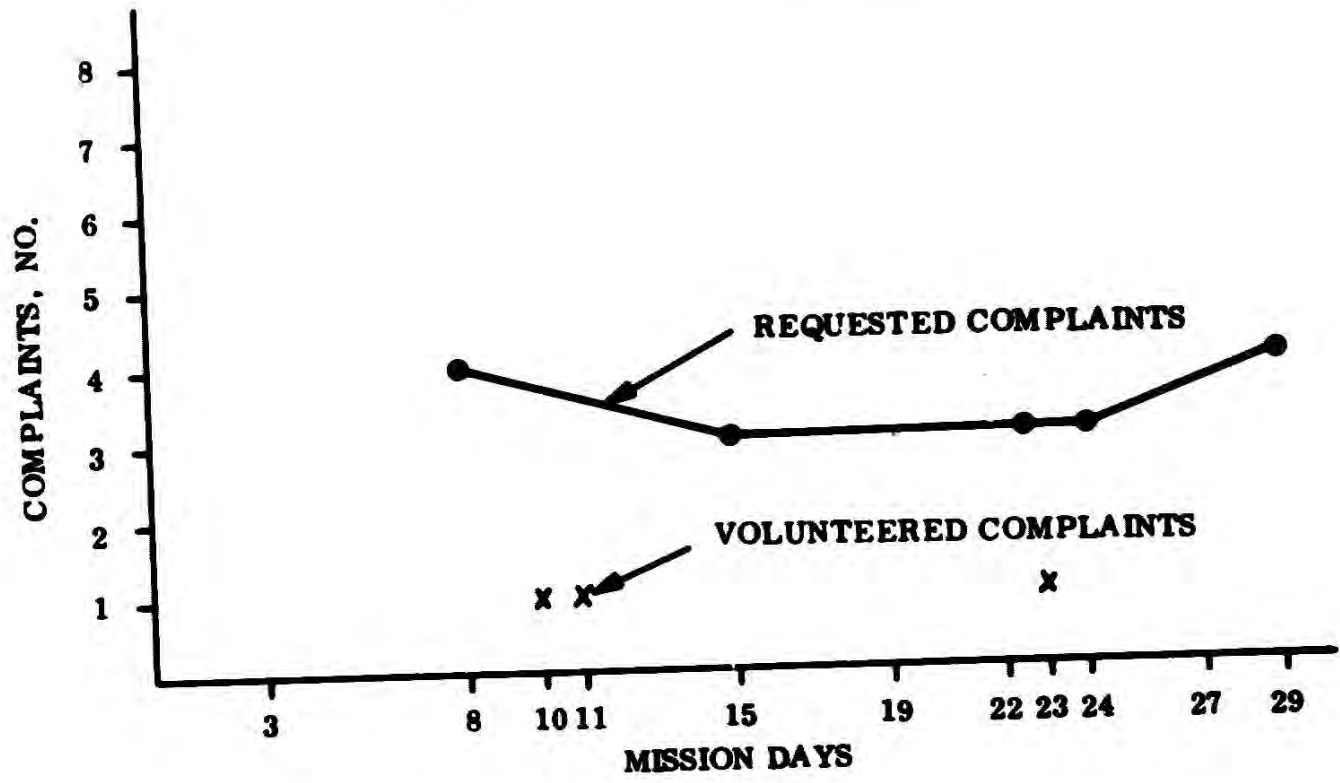

Figure 6-2. Bedding Complaints

Sock and underwear changes should be daily. Bedding in Space Station tie-down bunks may require more frequent changes than in the BEN FRANKLIN if used as a place for reading and writing. While some storage arrangements have been worked out, a laundry system should be developed to minimize the storage requirements in future Space Stations.

SECTION 7

PERSONAL HYGIENE

Facilities provided on BEN FRANKLIN allowed near normal personal hygiene habits in ocean going vessels (see Figure 7-1). The only limitations were the lack of hot water for showering and the elimination of all aerosols (deodorants, after shave lotions, etc.) due to contaminant generation. The shower was used sparingly (no hot water) and the men resorted to sponge baths. Common use of head and shower by the six men did not cause complaint. Non-aerosol shaving creams were utilized and half the crew used electric razors. Except for these minor inconveniences facilities were adequate. On future missions it is planned to provide for hot showers.

During debriefing sessions, no comments or complaints were made with regard to odors or foul air, except for the last week of the mission. The macerator for the head broke down during the last days of the mission. There was also a surge of air from the waste tanks when the slight pressure buildup was relieved upon opening the hatch at the end of the mission. The odor control did not work as well as anticipated during the GSDM. The crew complaints were usually on odor control as illustrated in Figure 7-2. The same problem could be a source of general annoyance in a space station.

The hygiene facility on the BEN FRANKLIN was not analagous to the Space Station with a zero g environment; however, the devices used in space station hygiene facilities may be tested in follow-on space station analogs to gain experience and learn more about the crew interface problems. A central hygiene facility with a slight negative pressure in the waste system and effective use of antimicrobial agents with odor removal canisters requires investigation. The desire for hot showers did point out the need for providing for adequate bathing in future space stations.

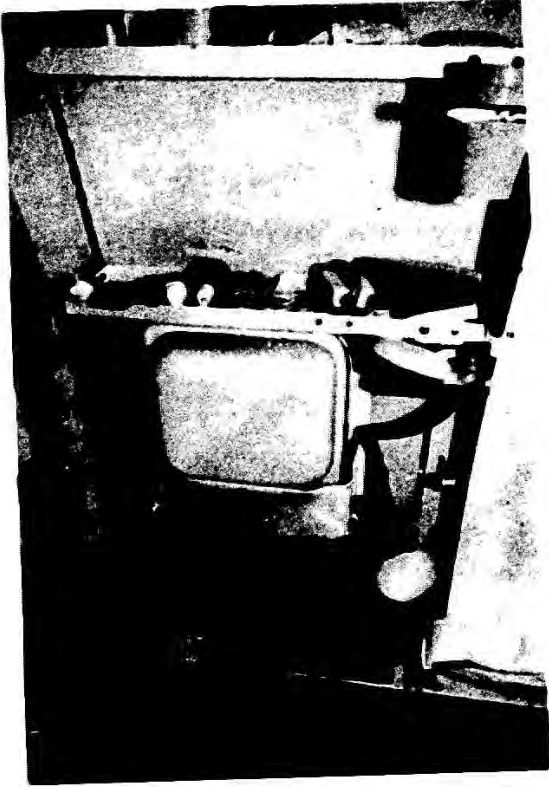

SHOWER AREA

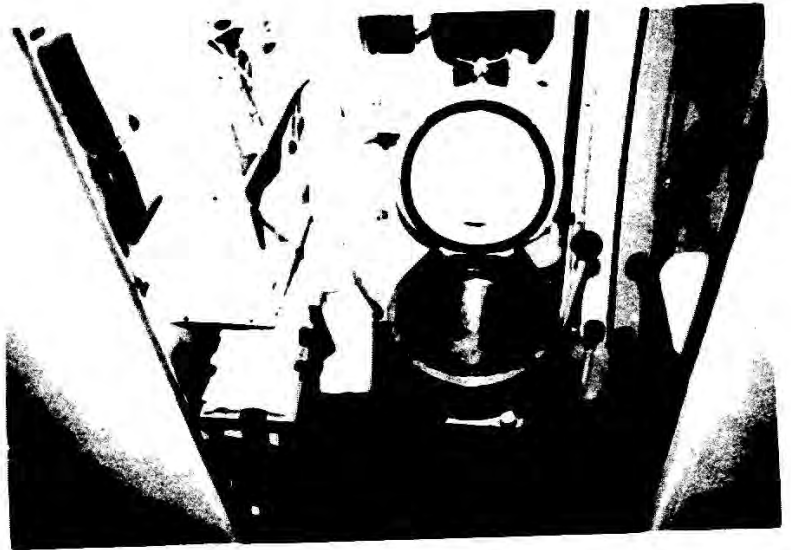
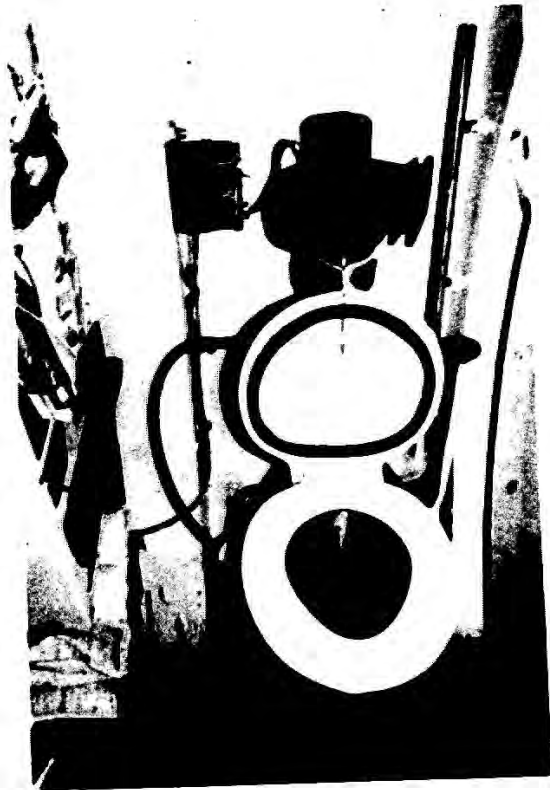

HEAD LAYOUT

Figure 7-1. Hygiene Facility

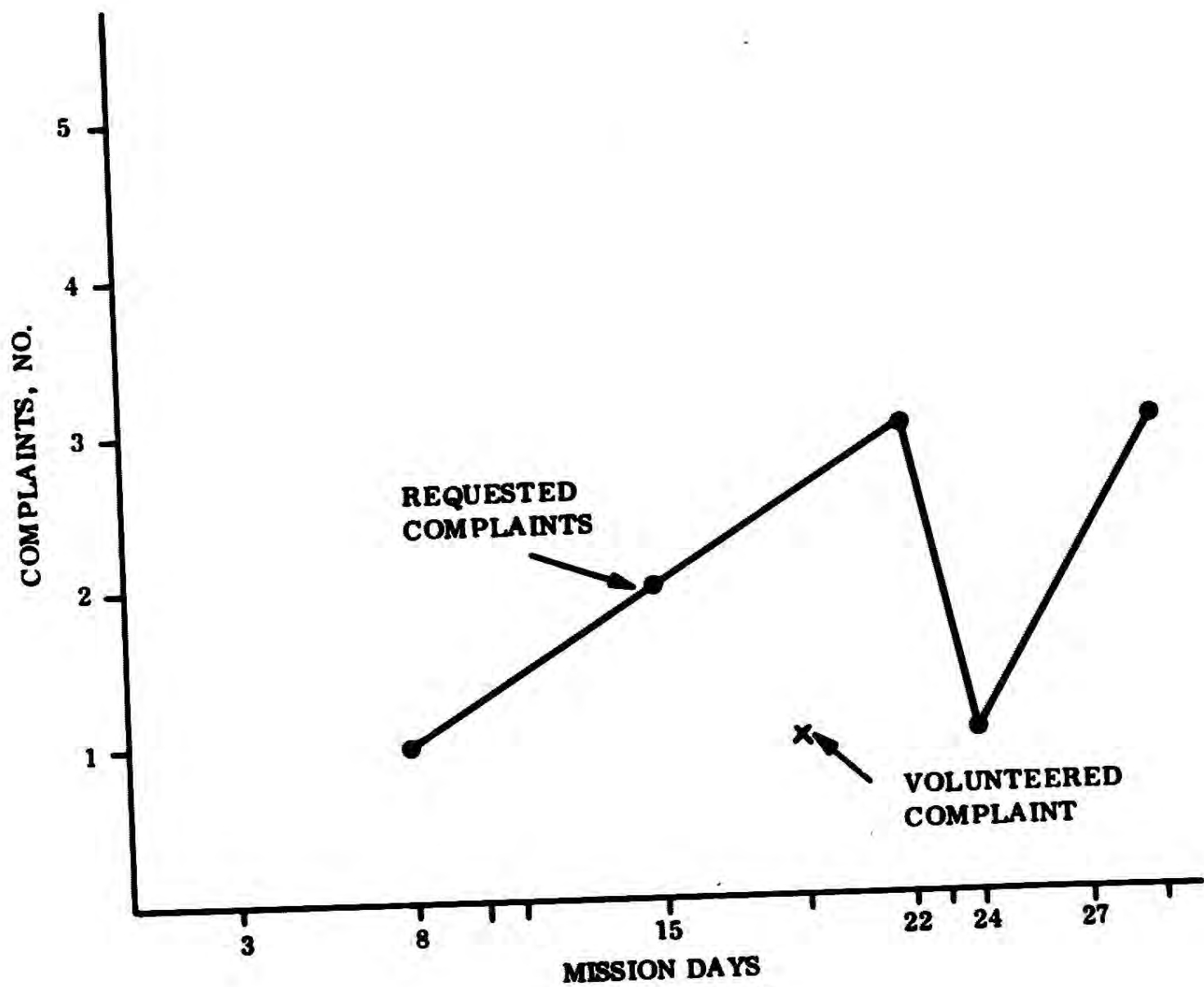

Figure 7-2. Odor Control Complaints

SECTION 8
NOISE LEVELS

Noise measurements were obtained with a General Radio 1565-A meter and the data were recorded every third day in the ward room, galley, and scientific area (Figure 9-1). These data are illustrated in Figures 8-1a through c (Vol. II - Figure 4-6).

Noise levels are generally less than that of existing spacecraft or an accounting office; for example, the noise level in a large office usually is between 60 and 80 decibels. Other typical overall noise levels are illustrated in Figure 8-2 with the BEN FRANKLIN data.

The noise complaints reported by the crew are presented in Figure 8-3. There were 3 complaints during the dive phase, 4 complaints on Day 15 and then one per day during the cruise phase of the mission.

The complaints were generally concerned with the difficulty of sleeping or resting while the macerator and other noisy equipment were operating and trying to concentrate on their work while other crew members were talking or moving around.

The sleep recall data (Volume II) indicates that the crew had a difficult time sleeping during Day 22 which is when the noise anomaly was measured. However, the average noise data do not correlate with the sleep recall data during the dive phase, when some crew members were active for 14 hours per day. Comparison of the noise data to the maintenance daily work load indicates sound levels increase with activity in the BEN FRANKLIN (Volume V).

Complaints by the crew will probably be expressed in future space stations if noise isolation is not maintained between the sleeping and working areas. However, background noise from the space station life support system may be such as to reduce man's sensitivity to random vehicle and people noises.

The system planned for future space station should not have any intermittent noise characteristics. A continuous soft hum was recommended by the crew as desirable.

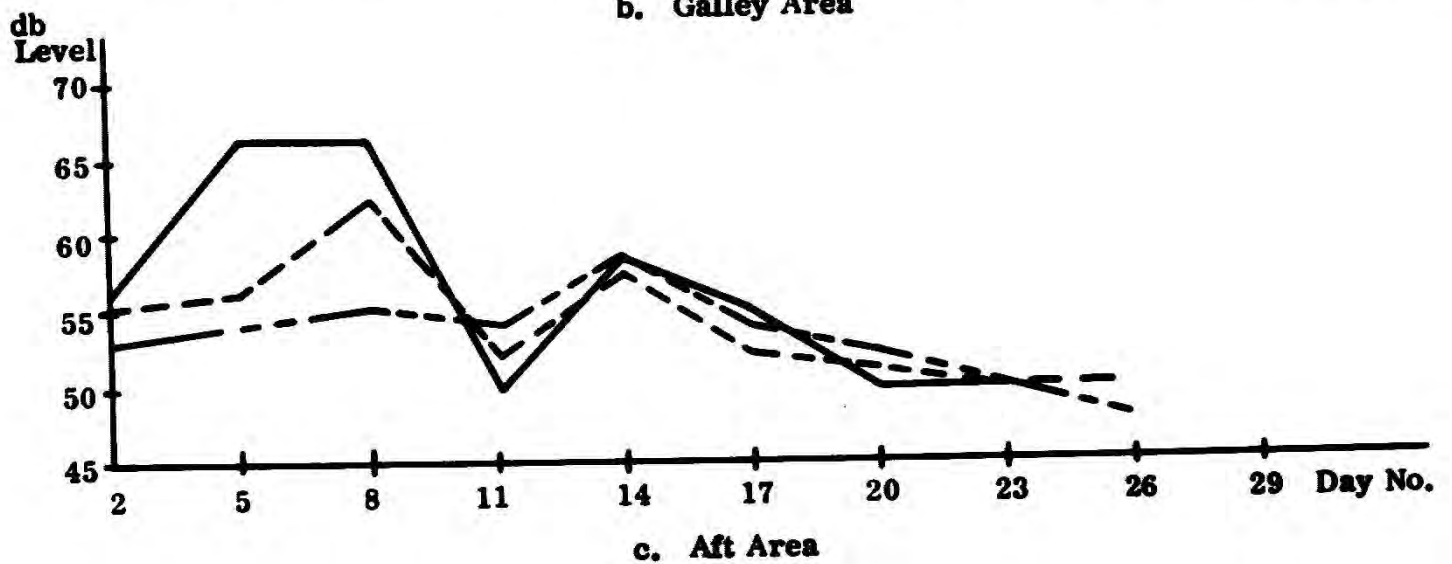
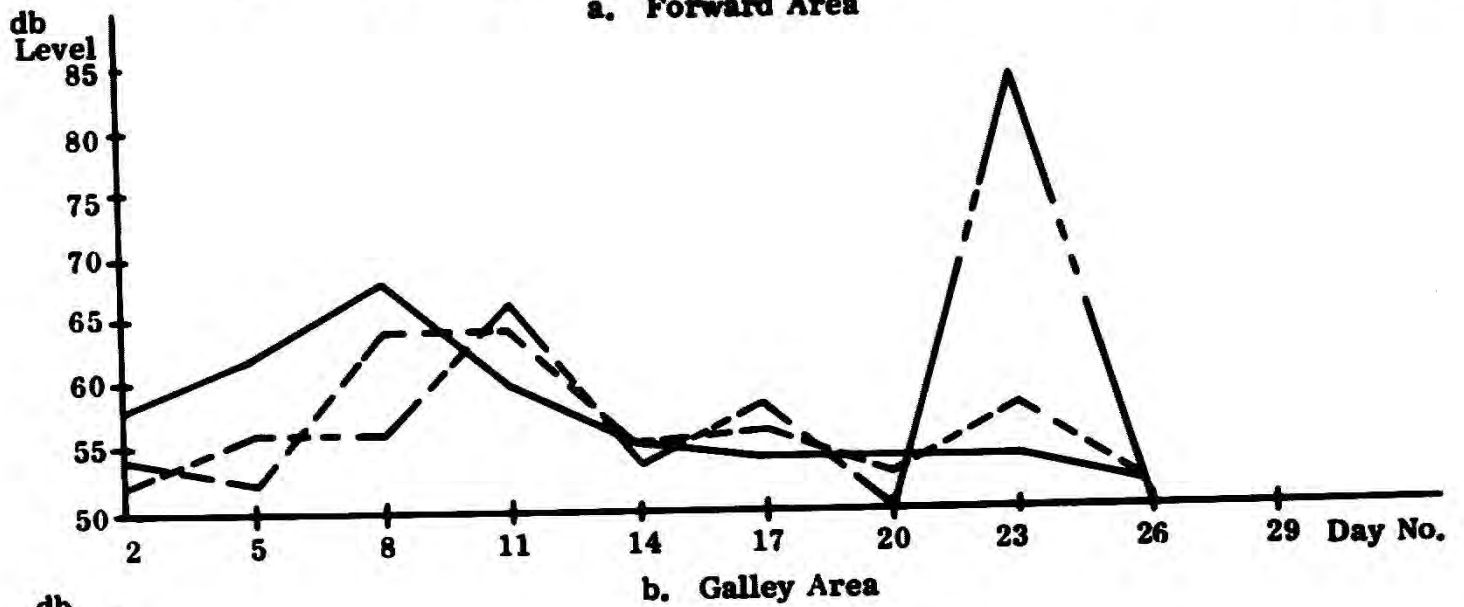
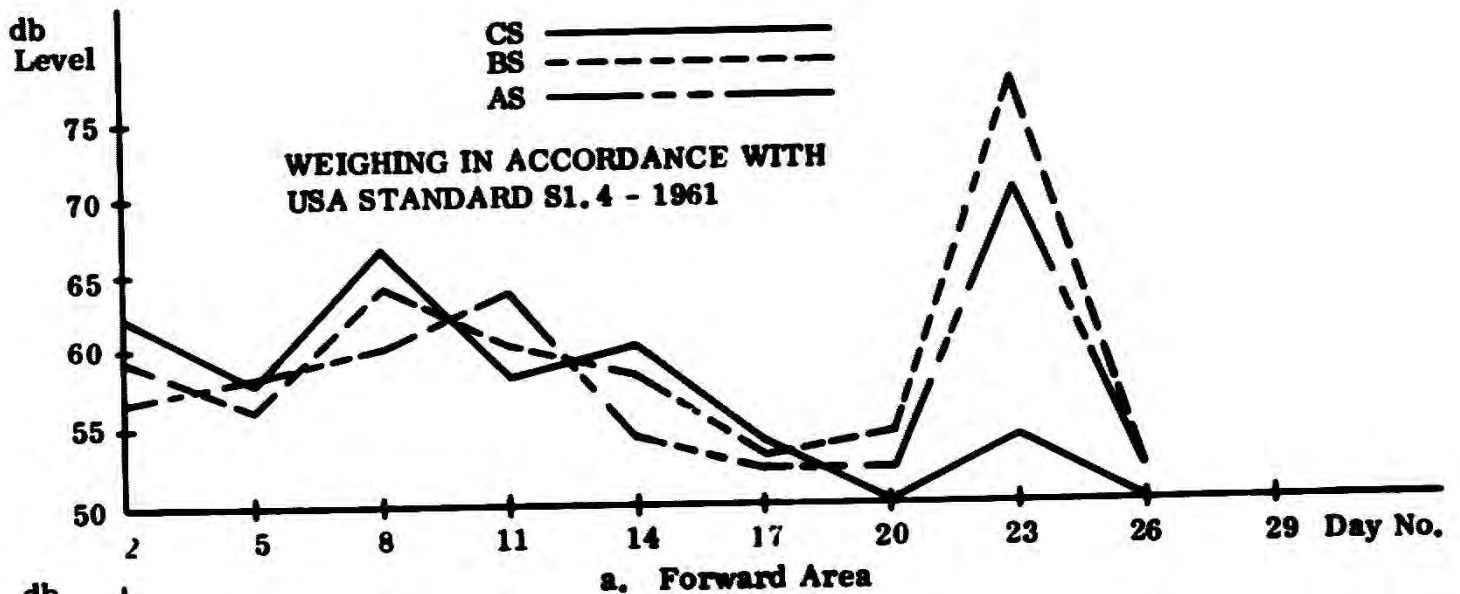
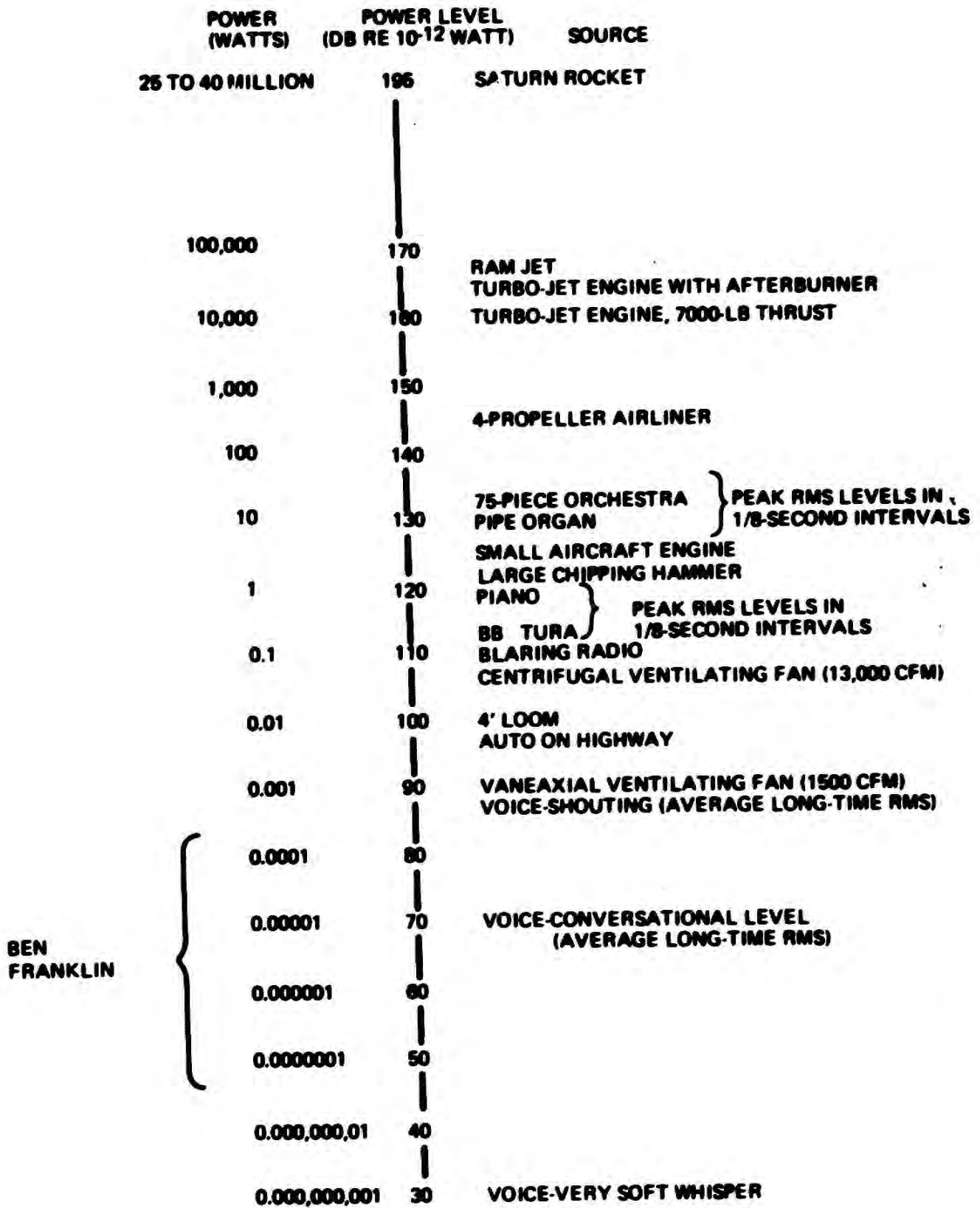

Figure 8-1. Noise Level Measurements db

ACOUSTIC POWER*



*GENERAL RADIO CO. HANDBOOK OF NOISE MANAGEMENT 5TH ED. 1963

Figure 8-2. Typical Power Levels for Various Acoustic Sources

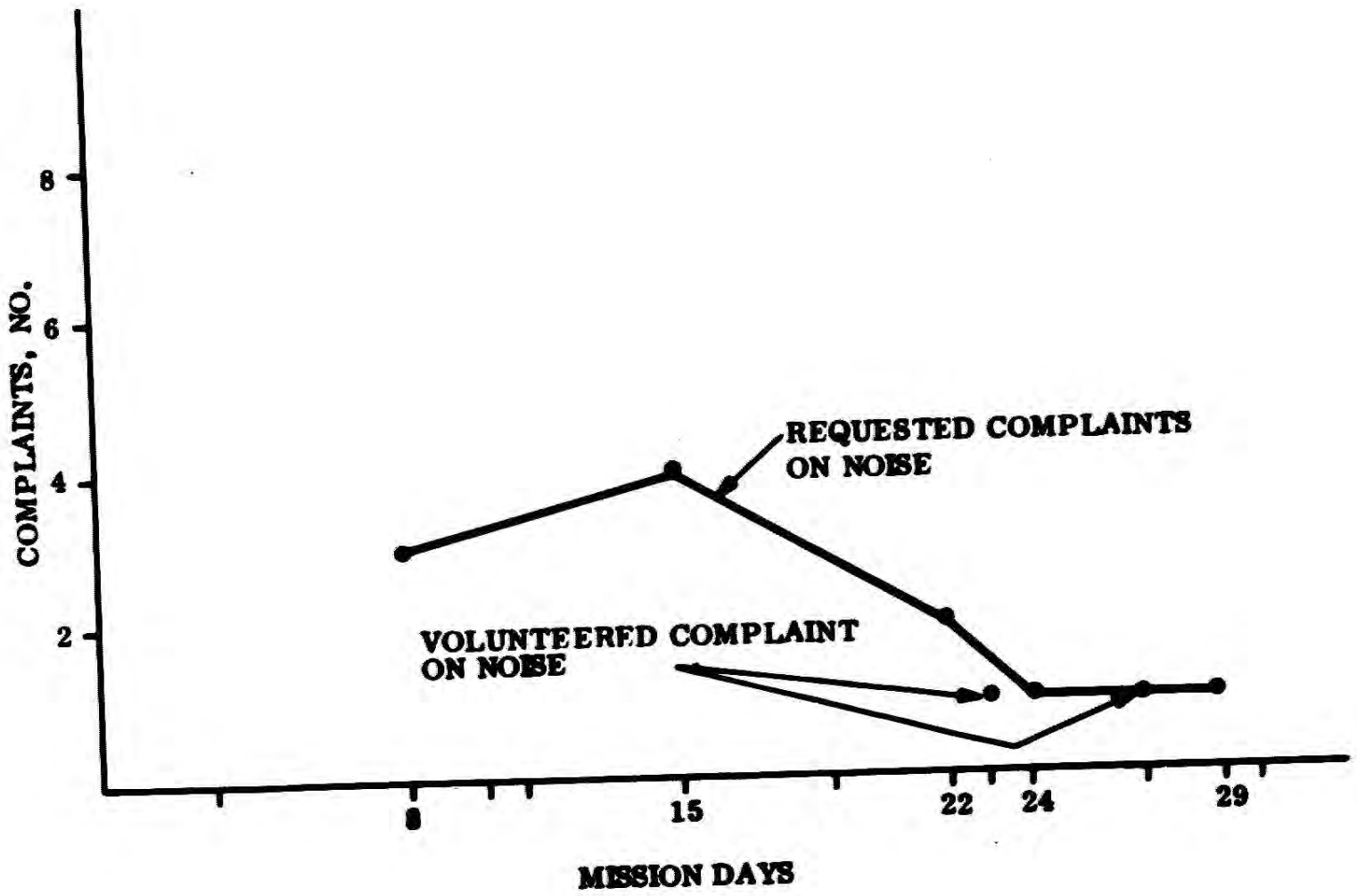

Figure 8-3. Noise Complaints

SECTION 9
LIGHT LEVELS

Light measurements were obtained with a Gossen TRI-LUX foot candle meter. The data were recorded every third day at pre-assigned locations, as illustrated in Figure 9-1. Figures 9-2a through c show the data recorded during the mission.

To conserve electric power, the only light initially used in the ward room was an 8-watt fluorescent lamp. The light level in the ward room (FWD HEMI) varied from 0 - 2.2 foot candles throughout the mission (Figure 9-2a) but averaged approximately 2 foot-candles. During the dive phase up to Day 8, the lights were turned off at targets of opportunity to allow oceanographic observation.

The light level was marginal for recording data, eating, and relaxing. The illumination was uniform because the light was reflected by the white walls of the pressure hull.

At Day 8, the total electrical energy consumed was within the budgeted power and the propulsion demand was less than anticipated; also since the magnetometer and sub-bottom profiler were not functioning, the power demand decreased. Therefore to provide higher light levels for reading, the 20-watt fluorescent was turned on in the ward room. On Day 14, both the 20-watt and 8-watt fluorescent lamps were on for reading, writing, and relaxation.

The crew's lighting complaints are presented in Figure 9-3. The data indicate no complaints during the dive phase (first 8 days) and three complaints on Day 15 during the cruise phase of the mission.

Lighting in the galley was constant at 2 foot-candles (Figure 9-2b). The lights in the scientific area were turned on and off to satisfy the scientific work schedule and sleeping/relaxing in the bunks (Figure 9-2c). Note that the light level data follows the observed pattern of the crew reading, writing, and working during the mission. Essentially, the light level was dictated by the type of activity in the BEN FRANKLIN. Complaints from the crew were generally about not having sufficient light to work and read. However, the crew was motivated to use flash lights, pen lights, and head band lights to conserve power for mission objectives.

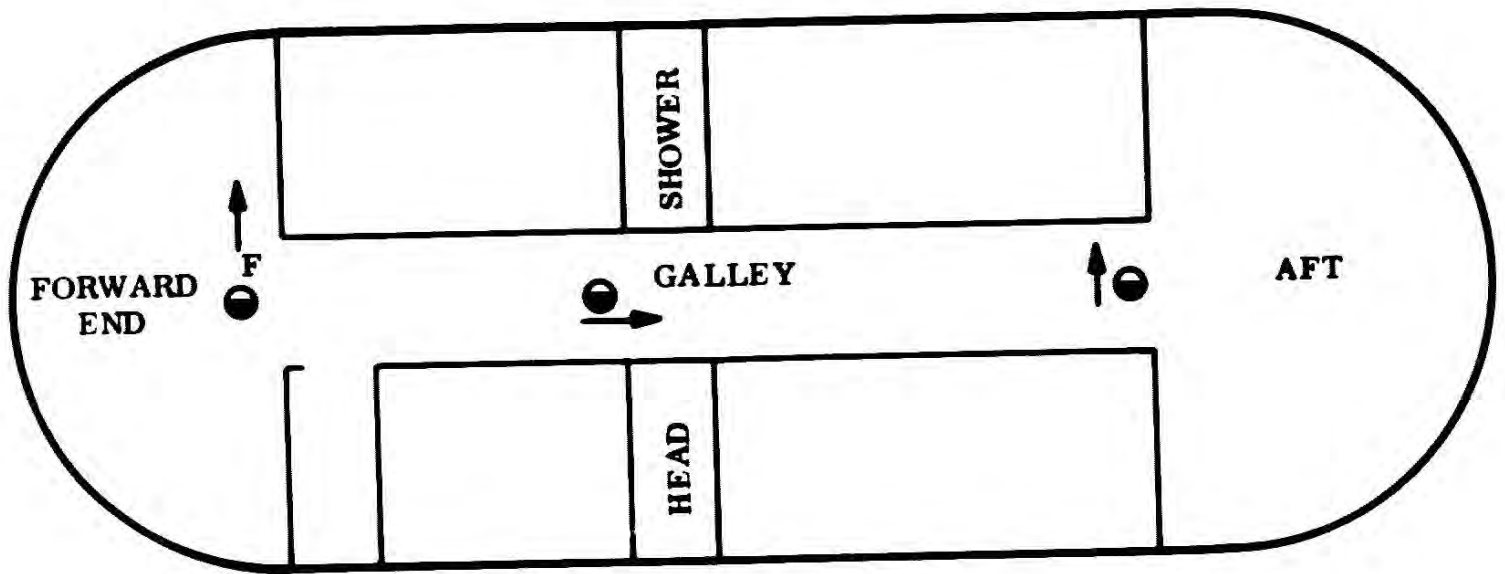

- NOISE LEVEL METER LOCATION
- LIGHT METER LOCATION

Figure 9-1. Location Diagram for Making Noise and Illumination Measurements

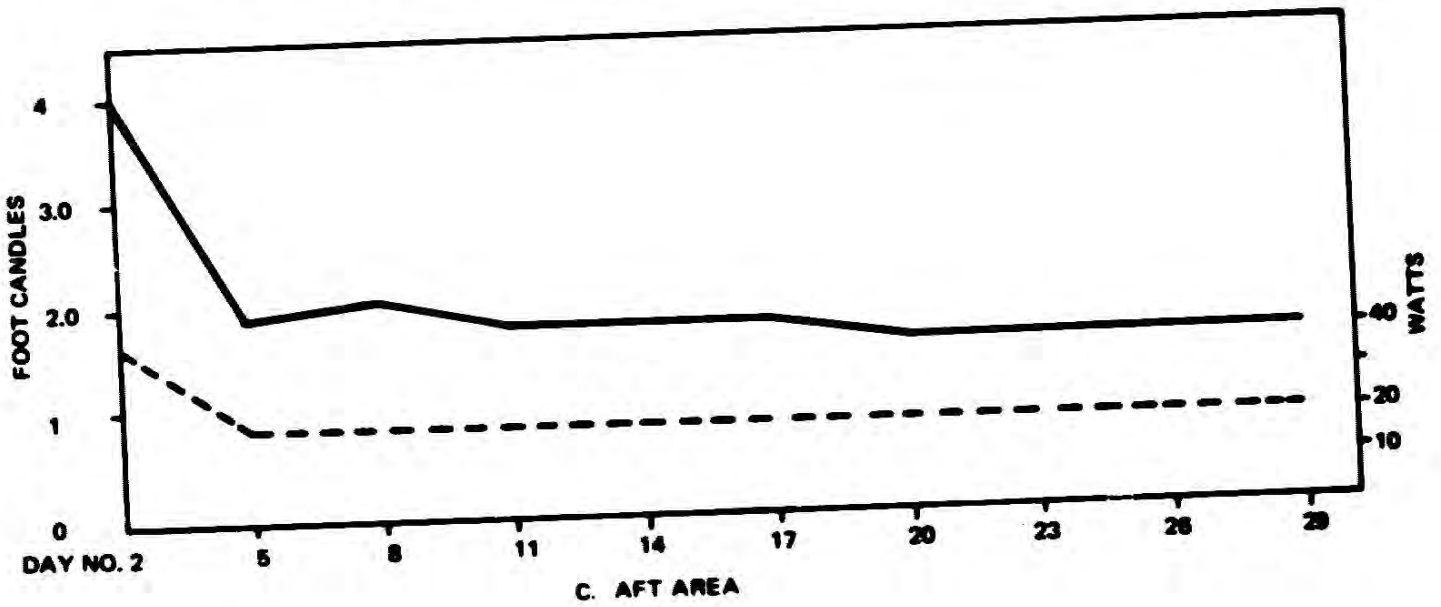
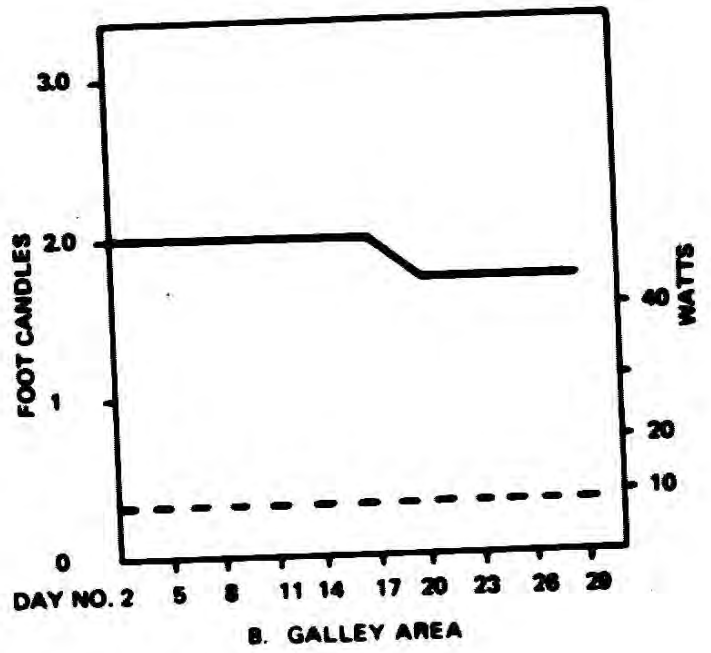
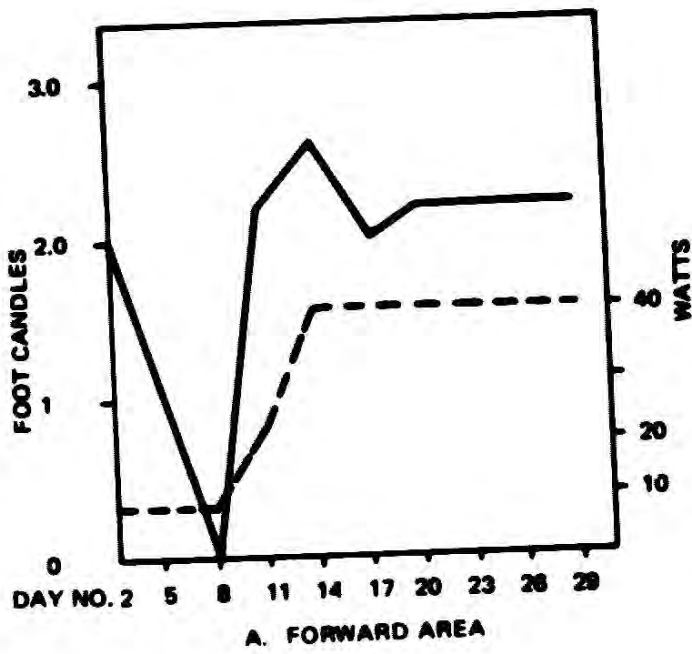

FOOT CANDLES —————
 WATTS - - - - -

Figure 9-2. Illumination Level Versus Source

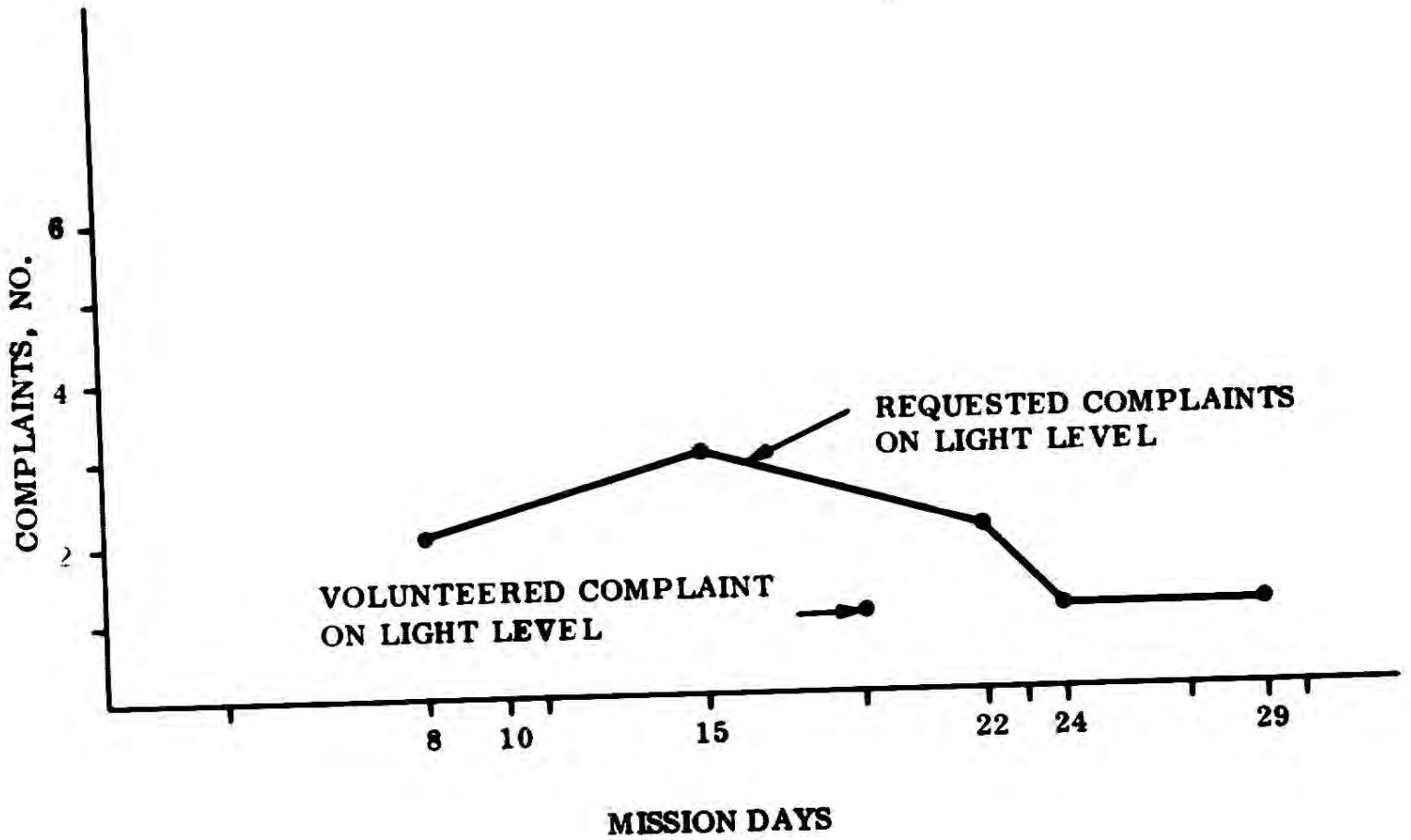

Figure 9-3. Light Level Complaints

The total illumination was below the light levels recommended for reading and working in space stations. The BEN FRANKLIN crew accepted the low illumination levels because it was planned before the mission to conserve electrical energy and use it for mission experiments.

Power for illumination can be minimized by using special reading lamps and background panel lighting. However, crew debriefing reveal that flood lighting is desirable for maintenance bench work.

SECTION 10

FREE VOLUMES AND AREAS

Man's tolerance limits to confinement leads to consideration of the minimum acceptable area and volume necessary to achieve and maintain a satisfactory physiological and psychological state in the crew. A search of the literature leaves many unanswered questions on acceptable levels of area and volume. Volumes/areas desired are 400 to 700 cubic feet/100 square feet per man for 30 to 60 day missions. However, the threshold of acceptable free volume is 150 cubic feet per man for a 30-day mission, with a free area undefined¹.

During the BEN FRANKLIN design phase, the approach was to provide an interior arrangement which is functional to perform a useful 30-day scientific mission with a 6-man crew. Based on this premise, the free volume was estimated at 500 cubic feet per man. Two years later when negotiations with NAVOCEANO and NASA were finalized, the mission plans were expanded to include ocean bottom surveys with additional on-board activities. The free volume per man decreased to 240 cubic feet with an area of 30 square feet per man.

The free volumes and surface areas allocated for each of the principal sections in the BEN FRANKLIN are illustrated in Figure 10-1. The free volumes are where the crew normally works and lives. It does not include extra air space behind tanks and other space used for storage of miscellaneous equipment.

The volumes in the BEN FRANKLIN were distributed among four basic activities and the results presented in Figure 10-2. Considering the BEN FRANKLIN as a bottom survey vehicle, 46.7% of its total free volume is used for work activities with 11.7% for public activity. During these bottom excursions, the ward room is used for oceanographic observation and other scientific work. On a cruise drift day, when the vehicle is used for

¹ Reference--T. M. Fraser, NASA CR-511, July 1966, "The Effects of Confinement as a Factor in Manned Space Flight"

LOCATION	SURFACE AREA ft ²	USABLE FREE VOLUME ft ³	EQUIP. VOLUME ft ³
SCIENTIFIC	40.2	265	77
COMMAND/CONTROL	10.0	49	60
WARD ROOM	40.0	400	53
GALLEY AREA	23.0	176	136
HEAD	6.7	58	12
SHOWER	6.7	66	4
BUNKS (6)	—	236	39
OTHER AISLE SPACE	51.0	122	—
APPROX TOTAL	*177.6	1372	381

*BUNK AREA NOT APPLICABLE

Figure 10-1. Areas and Volumes

BEN FRANKLIN - GSDM					
		USED AS BOTTOM SURVEYOR		USED AS CRUISE DRIFTER	
ACTIVITY	PERCENT OF TOTAL VOLUME RECOMMENDED*	VOLUME AVAILABLE, (ft ³)	PERCENT OF TOTAL VOLUME, (%)	VOLUME AVAILABLE, (ft ³)	PERCENT OF TOTAL VOLUME (%)
WORK	40	714 ①	46.7	314 ②	20.6
PUBLIC	25	176 ②	11.5	576 ①	38.0
PERSONAL	20	397	26.2	397	26.2
SERVICE	15	240	15.8	240	15.8

NOTE ① WARD ROOM VOLUME IS INCLUDED

② WARD ROOM VOLUME IS NOT INCLUDED

Figure 10-2. Free Volumes (Recommended vs Available)

recreation, only 20.6% of the free volume is for work activity because the ward room is used for reading, writing, and recreation. Use of the ward room for relaxation accounts for the 38% allocated for public activities. Actually, the crew makes room to relax when there is a pause in the mission work plan. Photographs of the crew relaxing are shown in Figures 10-3 and 10-4.

These data were substantiated by an analysis of the time lapse photographs. The bottom survey Day 1 illustrated how the BEN FRANKLIN was used as a scientific work vehicle. The work activity by area for each hour of Day 1 is illustrated in Figure 10-5. The same applies for Day 25 when the BEN FRANKLIN was cruising at 880 foot depth. During that day, the crew used the ward room for reading, writing, and relaxing and the aft lights were out so that crew members could go to their bunks to doze, sleep, and relax. The activity during that day is illustrated in Figure 10-6. The crew used the vehicle to satisfy their individual needs within the confines of the mission work plan.

From the time-lapse photographs it was apparent that the crew were in each other's way. One crew member was forced to work out of his bunk because there was no other place to go (Figure 10-4).

The crew expressed their views on privacy and free space when asked to respond to certain questions in the logs, as illustrated in Figure 10-7. There were a maximum of four complaints on Day 15 which was the mid point of the mission. By this time the crew was experienced in performing their tasks. By the mission mid point, they had sufficient time to live and think about their vehicle habitability. The major crew complaint on privacy was that each man should have a space to call his own, other than the bunk for reading and writing.

Data from the personal logs did not reveal any psychophysiological problems during the 30-day mission. The crew emerged from the mission without any impairment whatsoever. The BEN FRANKLIN free volume for 30 days lies above the impairment zone as shown in Figure 10-8. The trend line in the figure indicates that the free volume in the BEN FRANKLIN is sufficient for a 60-day mission. The free volume of 240 cubic feet per man is adequate for a 30-day mission, however, the interior arrangement could be improved for more effective use of the same volume. For example, it is feasible to put small table tops with

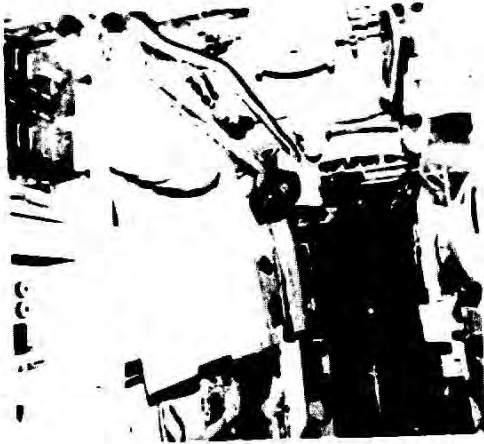
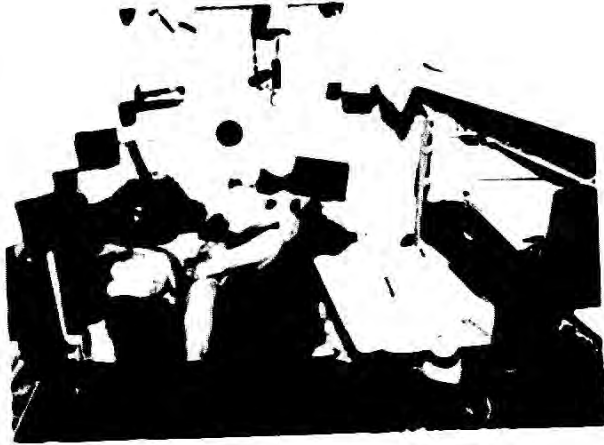
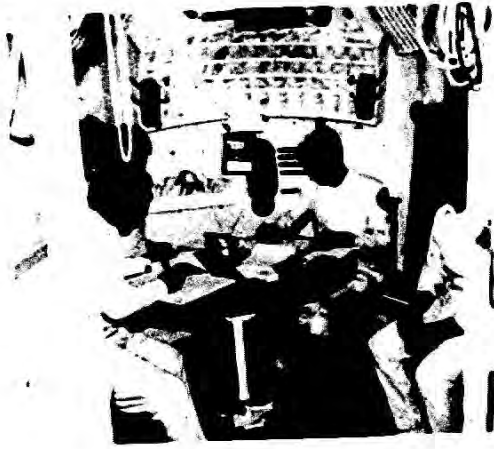

Figure 10-3. Relaxation

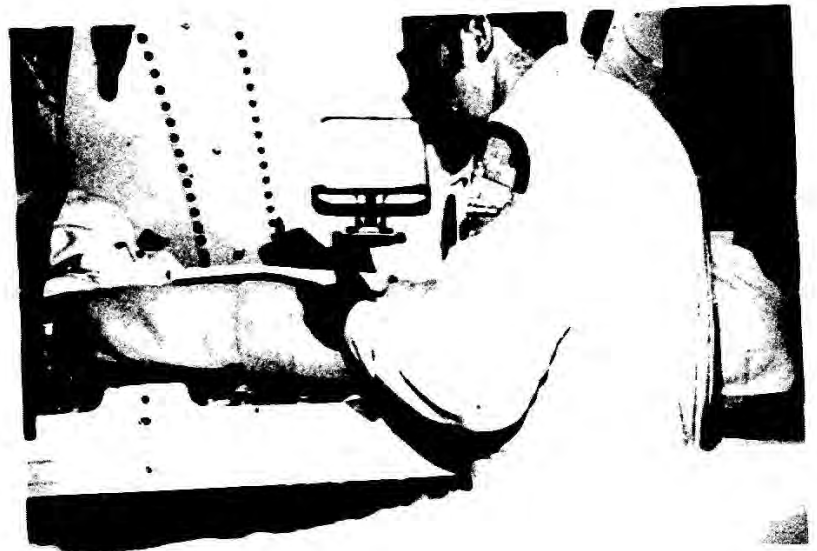
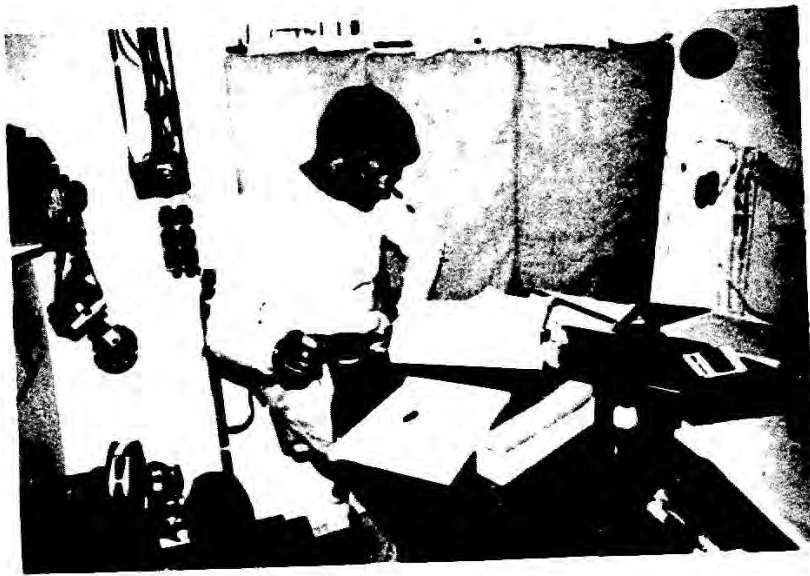

Figure 10-4. Habitability

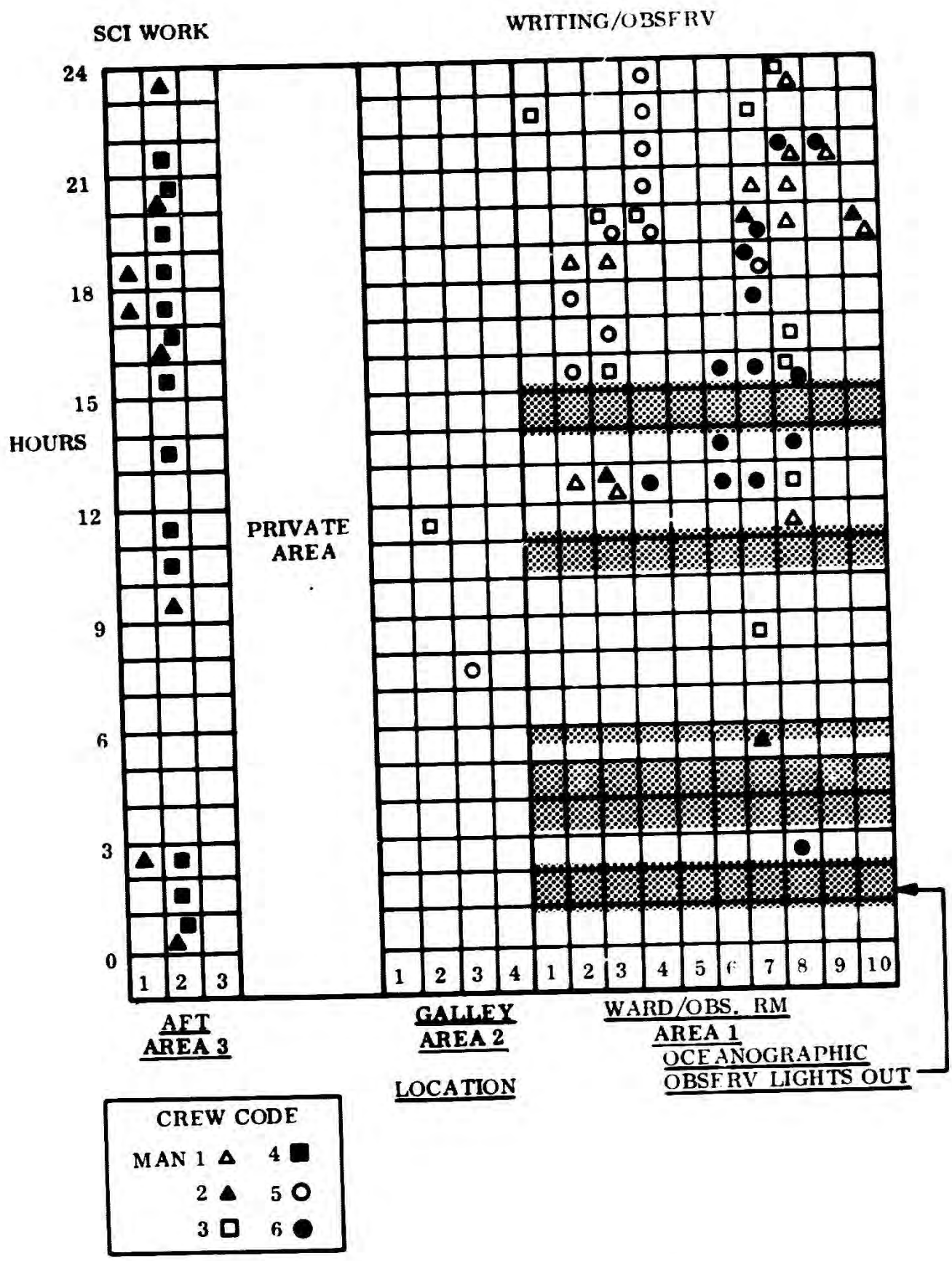

Figure 10-5. Habitability Activity, Day 1

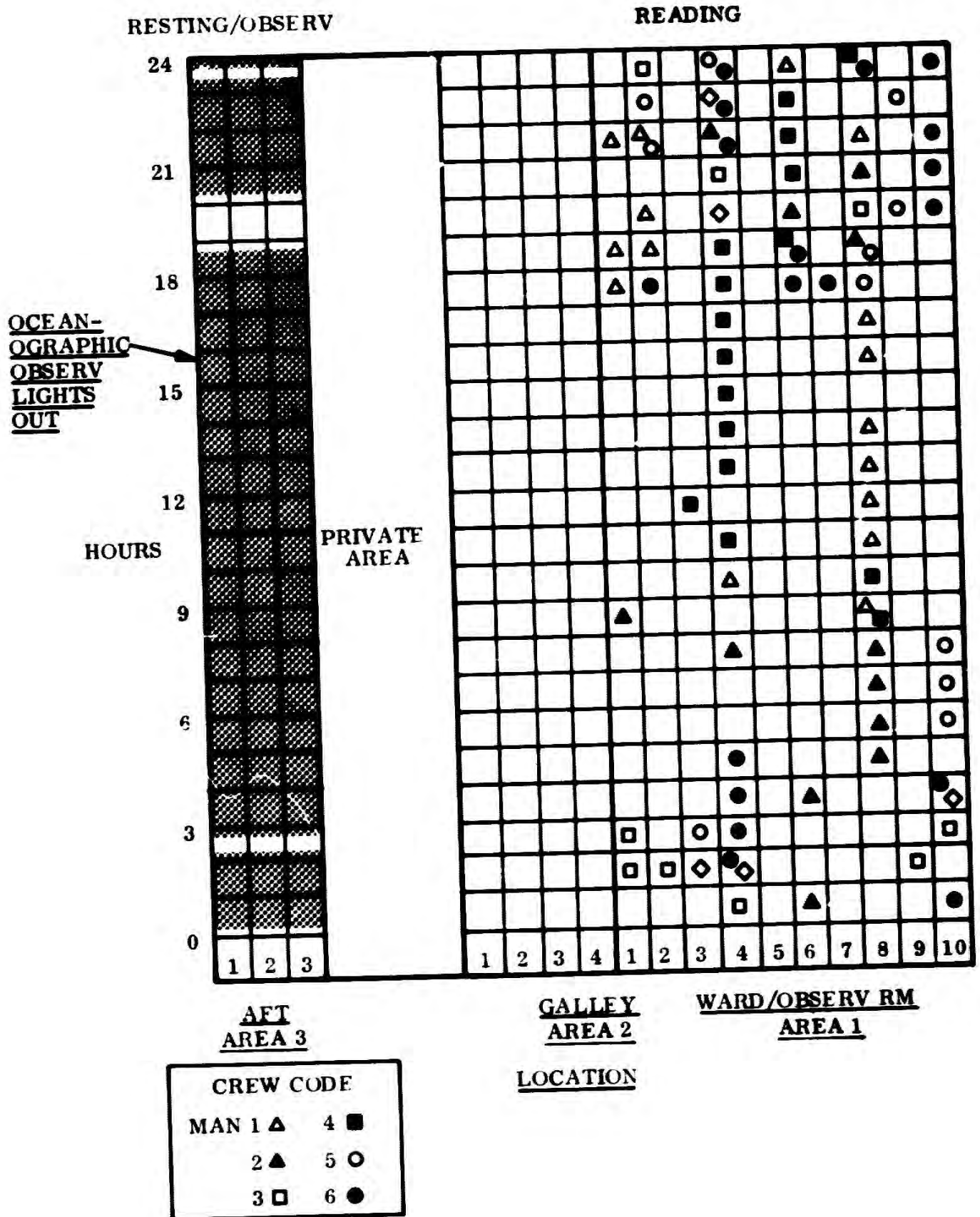

Figure 10-6. Habitability Activity, Day 25

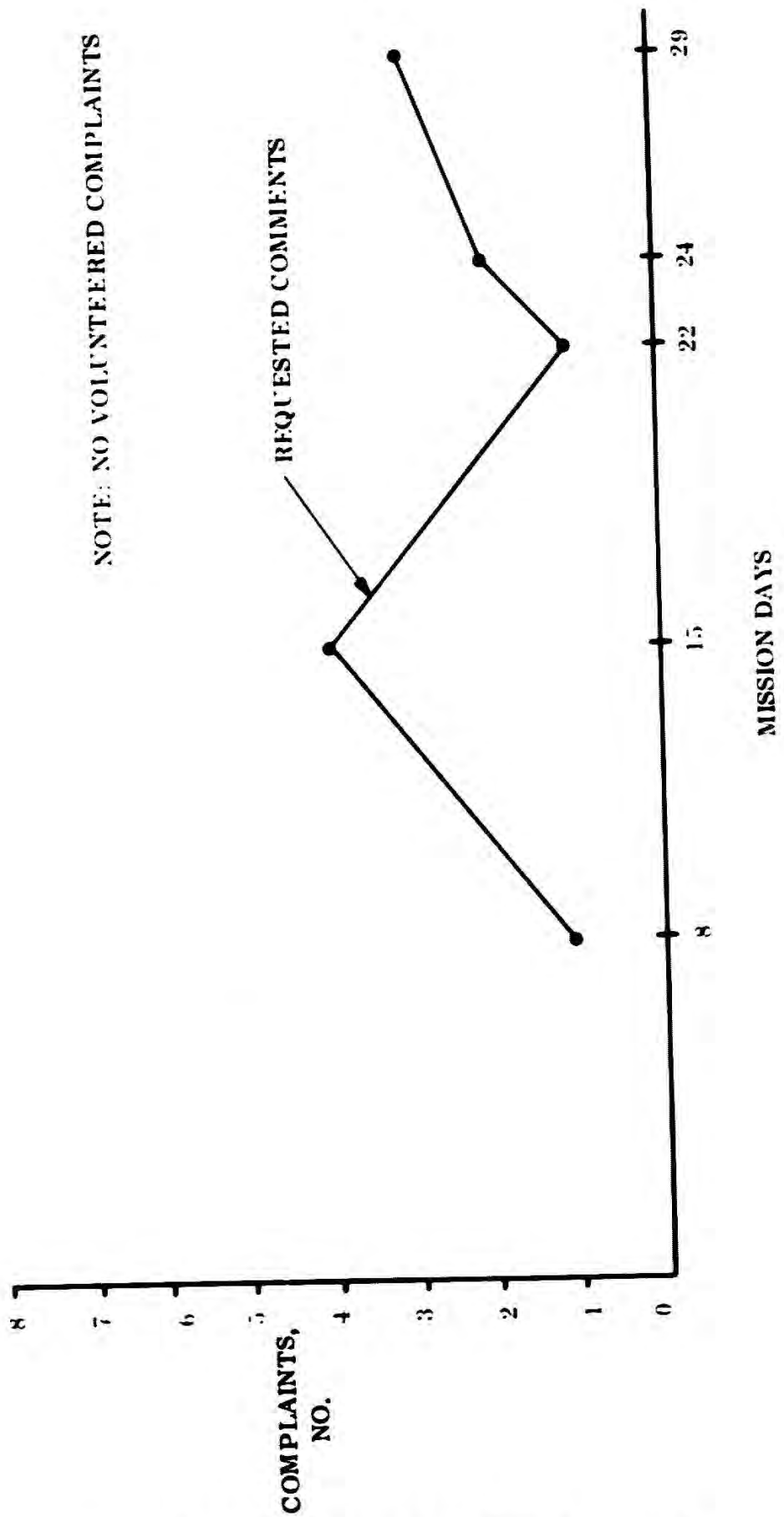

Figure 10-7. Privacy and Free Space Complaints

Ref: T. M. Fraser, NASA CR-511, July 1966, "The Effects of Confinement as a Factor in Manned Space Flight"

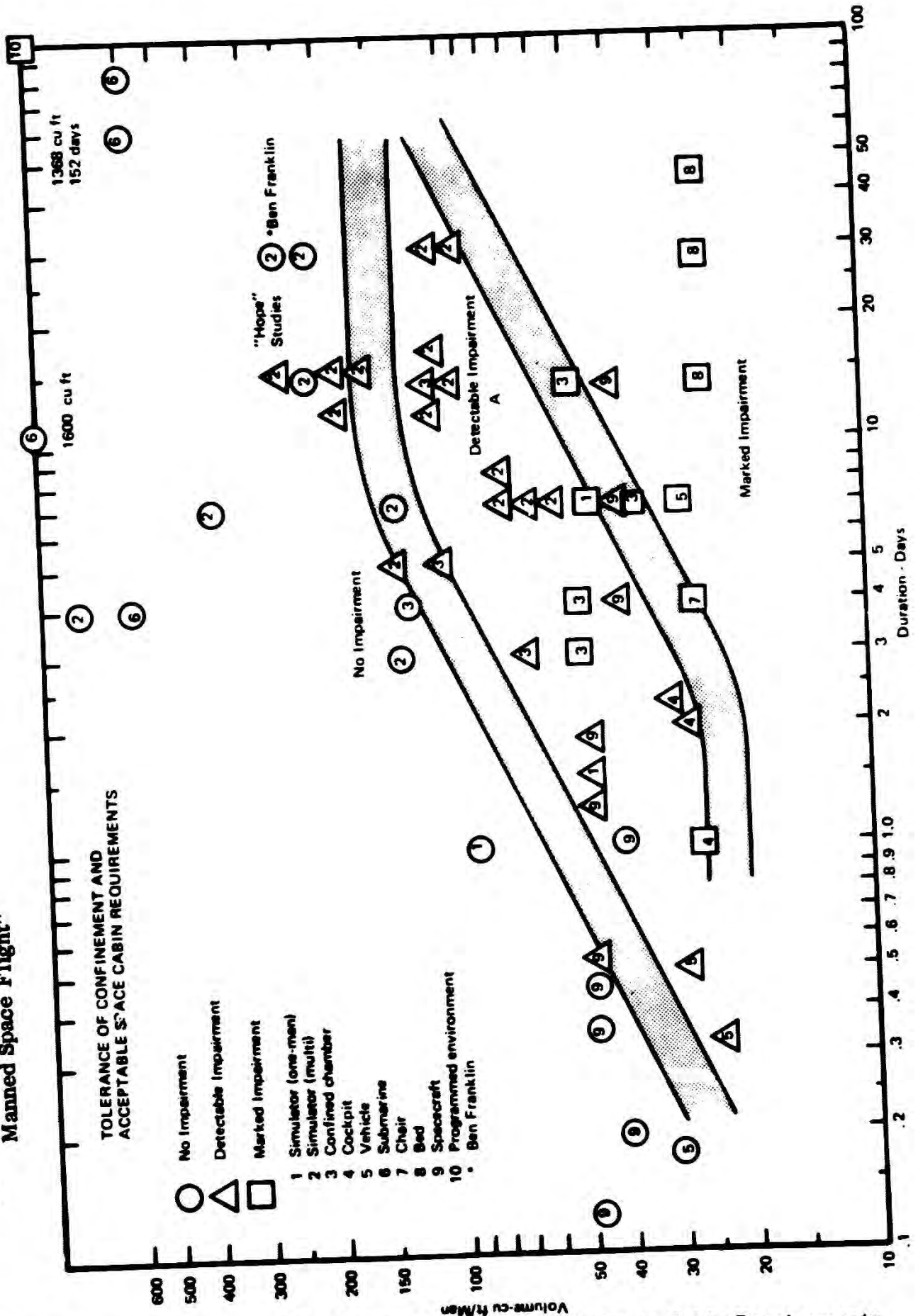

Figure 10-8. Tolerance of Confinement and Acceptable Space Cabin Requirements

shelving for each crew member. This could satisfy most of the crews complaints on not having their own area, for reading and writing. The same approach should be used in designing for future space stations. Another possibility is to incorporate a bunk of large volume. The bunk could be adjustable to form a lounge shape. With adequate lighting and bunk space, the crew member can read and write comfortably in his bunk. He may even go to sleep or doze in this position. Bunks planned for future space stations should have this flexibility to utilize the free volume available and make it comfortable for the crew.

SECTION 11
SUBJECTIVE HABITABILITY DATA

The 30 daily personal questionnaires for each of the six crewmen were analyzed with regard to specific complaints reflecting problems in the area of the habitability of the BEN FRANKLIN. On Days 8, 15, 22, 24 and 29, the crewmen were presented with a special questionnaire in which they were requested to comment on habitability and interpersonal relationships. On the remaining days, the men were asked to make general comments, to report irritating experiences and to respond to questions that indirectly would reflect their opinions.

Figure 11-1 shows the total number of complaints by all of the men on Days 8, 15, 22, 24, and 29. It will be noted that the number of complaints, 59, was highest on Day 15 and from this point on, the number decreased (to a low of 40 on Day 14). The uniformly high level of irritation and general annoyance on Days 12 through 16 explains the willingness of the crewmen to respond strongly to the questionnaire. The apparent decrease in number of complaints following the mid-point of the mission is, misleading. Three of the six men became bored with the repetitive nature of this comparatively lengthy questionnaire and reported that their complaints were the same as before or that they no longer were willing to explain or even bother to report all of their complaints. However, it is interesting to note that the volunteered complaints on habitability are few in comparison to the requested comments. The complaints were highest from Days 11 through 19 for volunteered complaints, with a maximum of 6 complaints on Day 10.

The major complaints made by the crew on a requested basis are illustrated in Figure 11-2. The volunteered complaints are also presented in Figure 11-2 to illustrate repeated complaints.

The top ten requested complaints and the volunteered complaints are in all probability the kinds of complaints to be expected in future space stations. After communications complaints with mission control comes food, clothing, and crew comfort

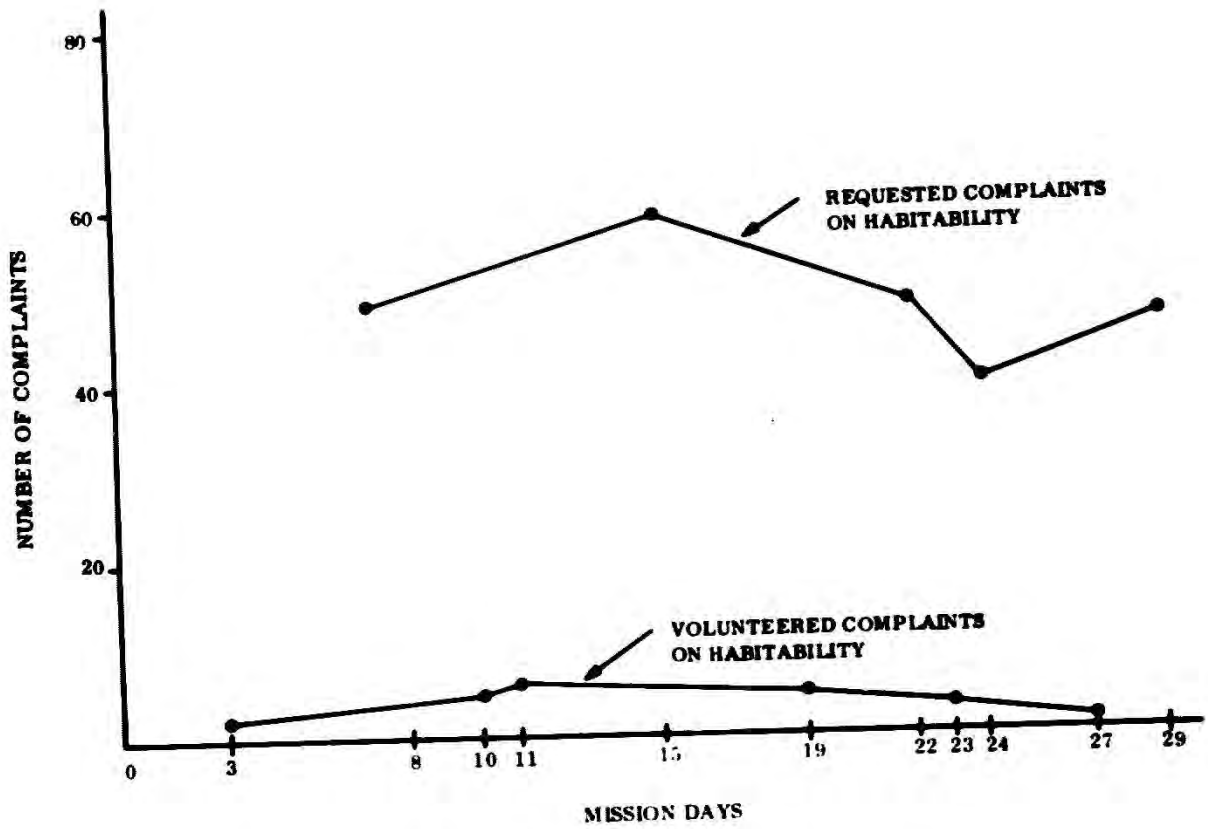

Figure 11-1. Overall Habitability Complaints

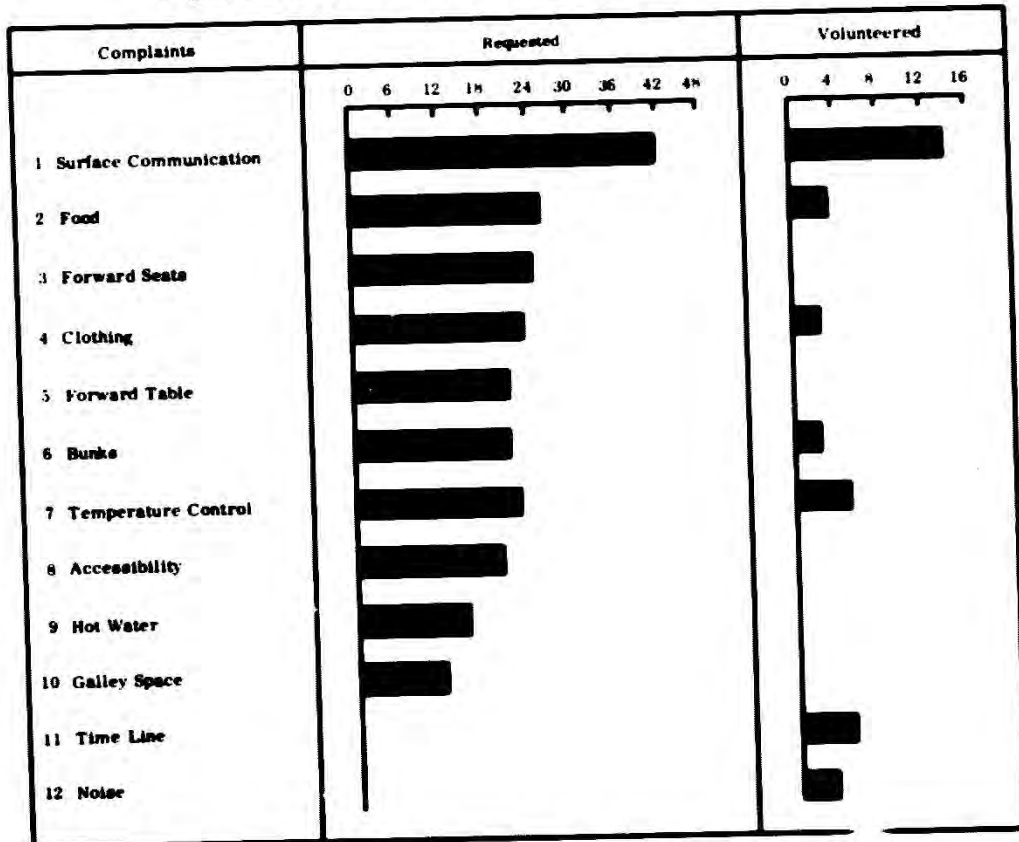

Figure 11-2. Major Habitability Complaints

complaints. Each of these complaints are discussed in other sections of this report. The intent here is to give the quantitative results from the logs as an overview of the crew's response in an isolated/confined environment.

Future goals should be the resolution of these complaints with follow-on space analog programs to obtain more sensitive data on crew response. The response from crews will determine the effectiveness of the solutions attempted on food, water, clothing, and crew comfort.

SECTION 12

CONCLUSIONS AND RECOMMENDATIONS

12.1 HABITABILITY ANALYSIS

The techniques used in the habitability analysis, based on time-lapse photographic records, provide a basis for habitability prediction techniques applicable to future space craft programs.

12.2 ENVIRONMENT

Environmental monitoring, including trace contaminants, is possible with simple manual equipment now available. However, the process is tedious and should be automated whenever possible.

12.3 FOOD

Facilities for preparing hot meals and an adequate selection, based on the preferences of the actual crew are of prime importance. Adequate power must be made available for preparation of hot food and for clean-up. Pantry storage designed for individual selection is also desirable.

12.4 WATER

The potability of the cold water system was rapidly lost because of contamination - some of which developed outside of the system and was introduced through the taps. A simple automatic iodine application technique would probably maintain the cold water potability; however, the taste would cause complaint.

The water system should be designed so that it can be drained, inspected and cleaned periodically.

Hot water should be made available for periodic showering.

12.5 CLOTHING

Frequent changes of clothing, e.g., a daily change of socks and underwear, are necessary but they give rise to the problem of storage or cleansing during extended missions. The clothing issue must include garments which will protect against intermittent adverse temperature conditions.

12.6 BUNKS

Bunk space must be adequate for lounging and sleeping. A back rest should be provided to allow for reading and writing in a private area. This area should not double as storage space for personal gear. If possible, each individual should be allowed to select the degree of firmness of his mattress.

The sleeping area should be provided with a separate heat control to ensure adequate warmth without undue amounts of clothing.

12.7 HYGIENE

Waste disposal devices must be refined to increase their operating life and back-up systems must be provided. Odor control is sensitive to the type of microbial agent used.

The head and the shower should be placed in separate easily cleaned compartments. They represent the greatest source of contamination.

12.8 HOUSEKEEPING

Design must provide for adequate cleaning, e.g. the hygiene and galley areas should be designed with round corners and surfaces should be easily cleaned.

12.9 AREA UTILIZATION

The 240 cubic/feet per man of free volume was sufficient; however, a better allocation is desirable. For example, there should be a definite separation between living and working quarters. The mission schedule should also be flexible enough to allow the crew to adjust their work/recreation schedule to take advantage of targets of opportunity. Such flexibility allows a more efficient use of the free volume available in the work/recreation area.

12.10 NOISE

The noise complaints could be reduced by noise isolation between the sleeping and working areas. Equipment having intermittent noise characteristics should be avoided in future space stations.

12.11 LIGHT

Light levels should be equivalent to industrial standards for reading and working. The equivalent to a miner's head lamp is required for maintenance work in some areas.

APPENDIX A
CREW ACTIVITY ANALYSIS

The crew's activity on mission Day 1 are presented to give an example of the type of information which can be accumulated from the mission data. The crew's activity is broken down into 4 major categories as sleep, activity (i. e, work, reading, working, etc.) food preparation, and time spent in the private area.

A.1 MAN 1

The activity data for Man 1 give an overview of what he was doing in relation to the mission activity and the objectives at that time. For instance, consider Man 1 activity in Figure 2-16. His prime interest on Day 1 was making oceanographic observations. The data reveal that he was active in making oceanographic observations during the first three hours. He slept from 0300 to 0930 hours and then returned to his observation in the work room.

From the area utilization data we find he spent most of his time in the ward room and the private area. Notice in Figure 2-11, Man 1 went to the private area at 1500 hours because he is out of view of the cameras. Apparently from that time up to 2400 hours, he spent 50% of his time in the private area and 50% of his time in the ward room writing his findings for that day.

In summary, Man 1 distributed his time as follows:

	<u>HOURS</u>	<u>MIN.</u>
Sleeping	6	18
Activity	11	16
Food Prep.	0	20
Private	6	6

The allocation of time is in agreement with discussions with the Man 1 during the debriefings.

A.2 MAN 2

This man is a trained oceanographer with extensive experience. The Day 1 activity data on this man were reviewed. During this bottom survey day, he spent most of his time observing the ocean floor and working with scientific equipment as time permitted. He rested periodically for periods of less than one hour. Our interpretations of the observation data indicate that this man utilized his time effectively to obtain oceanographic data, even though the cabin temperature dropped to 55° F in the morning of the first day. Man "2" distributed his time as follows:

	<u>HOUR</u>	<u>MIN.</u>
Sleep	Not Recorded	
Activity	14	48
Food Preparation	0	42
Private	6	6

A.3 MAN 3

During the first hour of Day 1, this man checked the BEN FRANKLIN systems and retired during the second hour, according to the planned time line. At 0800 hours, he was ready to take over the watch routine from 0900 to 1200 hours inclusive. He continued to monitor ships systems and stay in the private area. At 2000 hours to midnight, he piloted the BEN FRANKLIN. Man "3" distributed his time as follows:

	<u>HOUR</u>	<u>MIN.</u>
Sleep	7	8
Activity	13	22
Food Preparation	0	22
Private	2	58

A.4 MAN 4

The first two hours of the mission were spent calibrating oceanographic instrumentation and checking the operation of certain equipment which will be operating continuously or periodically throughout the mission. After completion of his tasks, this man retired

until after 0800 the next morning. During the day he performed several oceanographic experiments, including accoustic experiments when the support Privateer dropped "sus" charges. This man spent most of his time working with the oceanographic equipment, which includes calibration, rewinding tapes, making adjustments, resetting dials, etc., etc. He distributed his time as follows:

	<u>HOUR</u>	<u>MIN.</u>
Sleep	3	56
Activity	14	0
Food Preparation	0	20
Private	5	44

A.5 MAN 5

This man was active for over 21 hours of Day 1 because of his sense of responsibility for the BEN FRANKLIN. The record does not show any time for sleeping; however, he did sleep for periods up to a half hour. He distributed his time as follows:

	<u>HOUR</u>	<u>MIN.</u>
Sleep	0	0
Activity	21	32
Food Preparation	0	12
Private	2	14

A.6 MAN 6

After working for 3 hours, this man retired for 7 hours. He made the necessary preparation for gathering data on activity inside the BEN FRANKLIN. In the private area, he set up shop to work because there was inadequate space to work in the ward room while the oceanographic experiments were in progress. He distributed his time as follows:

	<u>HOUR</u>	<u>MIN.</u>
Sleep	7	0
Activity	10	0
Food Preparation	0	20
Private	6	40

APPENDIX B
CREW TIME LOCATION ANALYSIS

The crew time location data for Days 1, 6, 8, and 25 are presented to give an example of the type of information which can be extracted from the mission data. These data are useful for determining how much the crew deviated from the planned time line. By referring to the crew activity data, the investigator can determine the reasons for the deviation.

B.1 MAN 1

Man 1 (Figure 2-16) did not follow the crew time line because:

- Targets of opportunity during the early mission phase
- Favored a day/night cycle
- Two pilots on board were prepared to take over his share of the pilot work load, until the mid-point in the mission. The two pilots anticipated that pilot relief from the scientist would be minimal during the early mission phase. The man's planned and actual activity summary in hours is:

Location	Planned Hours	Day	Actual Hours			
			1	6	8	25
Scientific	0		0	1	0	0
Private	9		9	11	9	11
Command/Control	2		0	0	0	7
Galley	3		0	2	1	3
Ward Room	10		15	10	14	3

For example, the pre-mission planning anticipated that this man would spend 10 hours in the ward room and he actually spent 15 hours in the ward room during the first mission day.

B. 2 MAN 2

Man 2 (Figure B-1) did not follow the crew time line because:

- **Targets of opportunity during the bottom survey**
- **Overall interest in vehicle operation and activity**
- **Rested when work was completed**
- **Depended on fellow scientist to complete certain scientific tasks**

The man's planned and actual activity summary is:

Location	Planned Hours	Actual Hours			
		Day 1	6	8	25
Scientific	11	6	5	9	3
Private	7	6	5	5	9
C/C	0	0	0	0	0
Galley	3	2	2	3	1
Ward Room	3	10	12	7	11

This man was in the scientific area for a maximum of 9 hours during one dive day, which is 2 hours less than the planned time.

B. 3 MAN 3

Man 3 followed the mission time line (Figure B-2) during the early mission phases; however, his work-rest cycle changed because a scientist relieved him from piloting during the second half of the mission.

The man's planned and actual activity summary is:

Location	Planned Hours	Day	Actual Hours			
			1	6	8	25
Scientific	0		0	0	0	0
Private	7		9	9	5	11
C/C	11		7	13	5	0
Galley	3		2	2	2	2
Ward Room	3		6	0	12	11

B.4 MAN 4

Man 4 followed the time line (Figure B-3) during the early mission phase, as follows:

- Worked continuously with the scientific equipment
- Performed maintainability tasks
- Followed time line rest cycle

During Day 25, he followed the time line rest cycle, but spent most of his time in the ward room reading, writing and talking.

The man's planned and actual activity summary is:

Location	Planned Hours	Day	Actual Hours			
			1	6	8	25
Scientific	12		13	11	13	0
Private	7		7	6	4	9
C/C	0		0	0	0	0
Galley	3		1	3	1	3
Ward Room	2		3	4	6	12

B.5 MAN 5

Man 5 spent most of his time (Figure B-4) piloting the vehicle and catching cat naps during the dive program. His sense of responsibility for the BEN FRANKLIN is the reason for not following a normal sleep schedule.

During Day 25, he managed to rest for 8 hours in the private area.

The man's planned and actual activity summary is:

Location	Planned Hours	Actual Hours			
		Day 1	6	8	25
Scientific	0	0	0	0	0
Private	9	1	3	0	8
C/C	11	16	11	16	15
Galley	2	0	3	3	1
Ward Room	2	7	7	5	0

B.6 MAN 6

Man 6 followed the mission time line (Figure B-5) during the early mission phase and later varied his rest cycle for the remainder of the mission. He worked in the ward room after other scientists completed oceanographic observations. When he could not work in the ward room, he worked in the private area near his bunk.

Location	Planned Hours	Actual Hours			
		Day 1	6	8	25
Scientific	0	0	0	0	0
Private	7	10	7	8	11
C/C	2	1	1	0	0
Galley	2	5	2	2	2
Ward Room	13	8	14	14	11

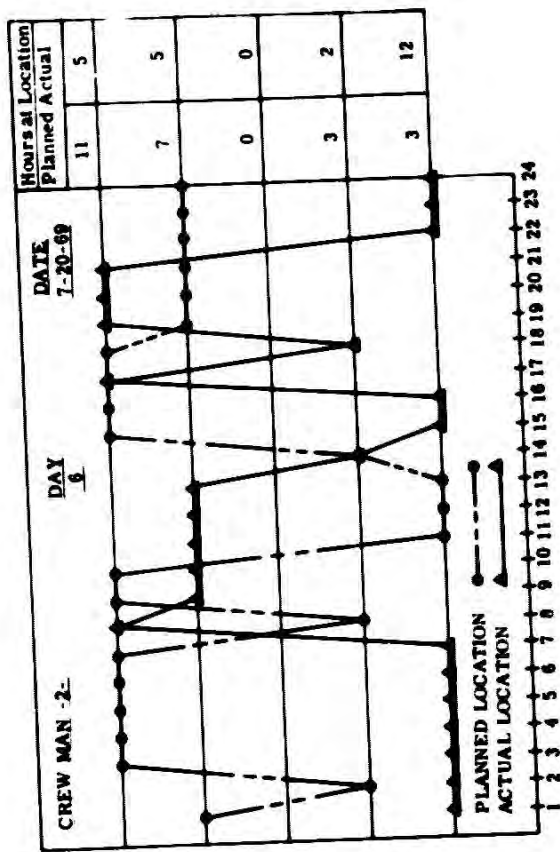

Day 6

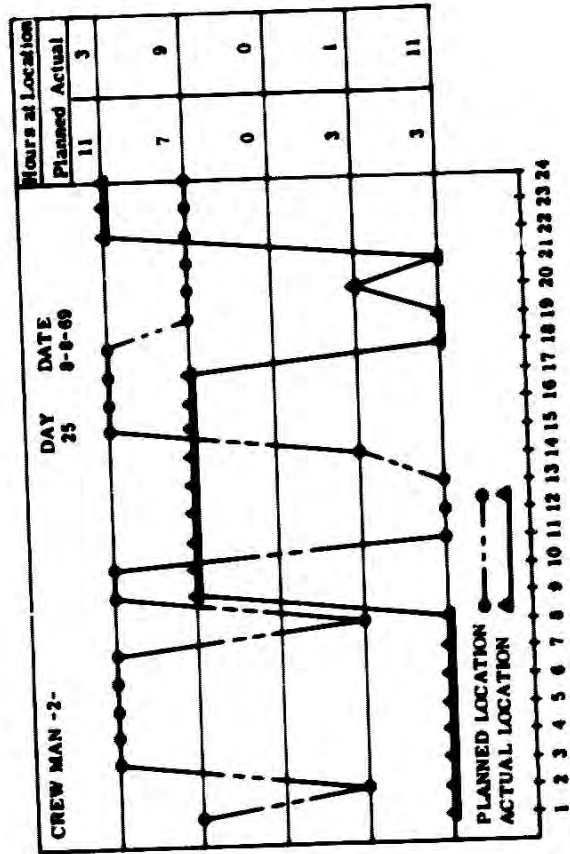

Day 25

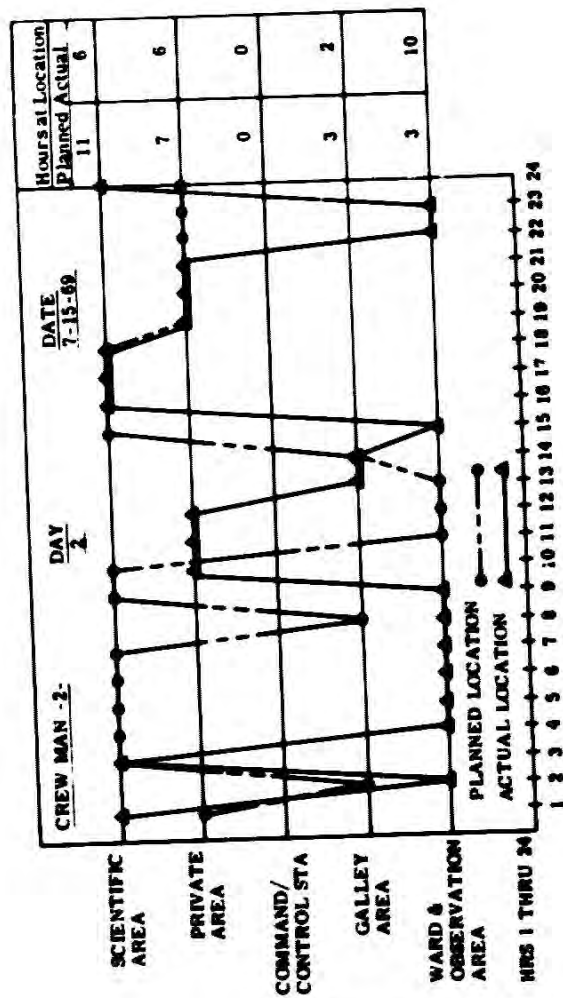

Day 2

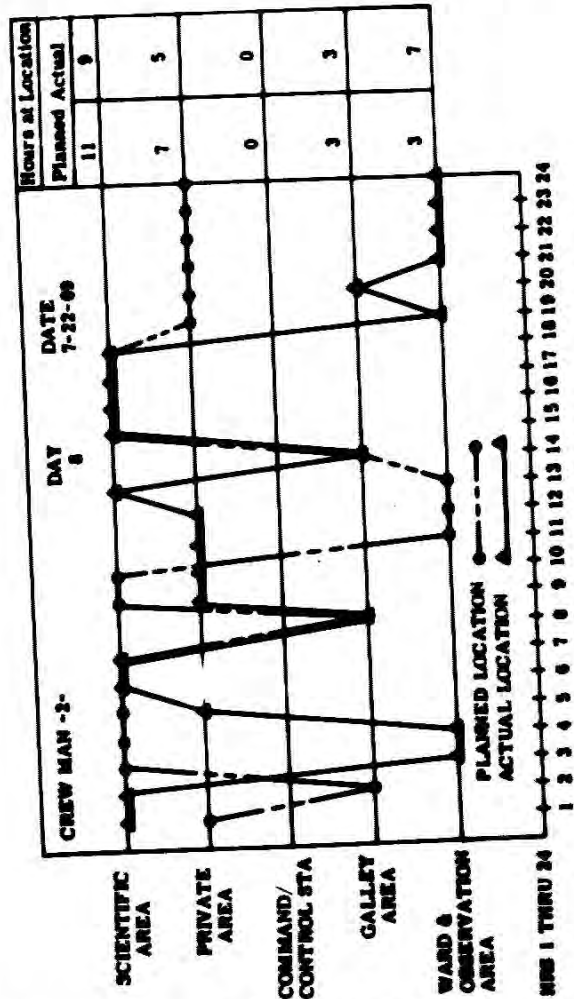

Day 8

Figure B-1. Actual Versus Planned Time Line, Man 2

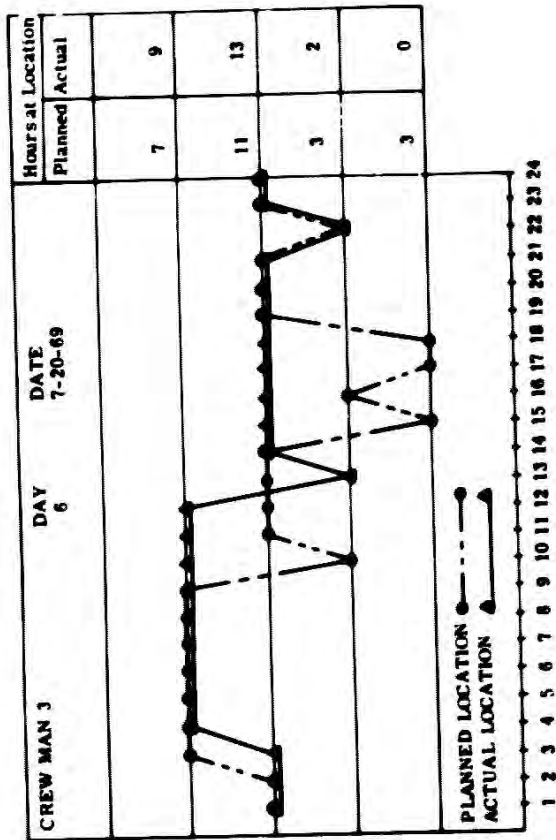

Day 6

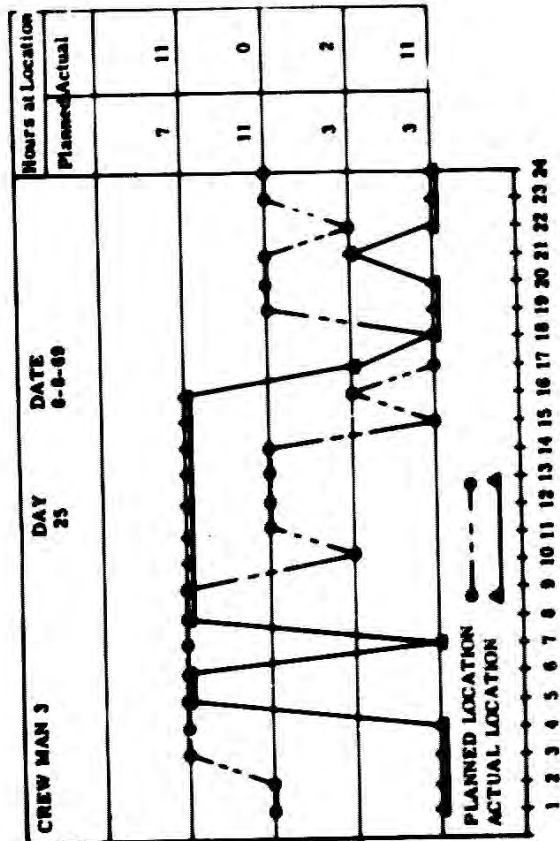

Day 25

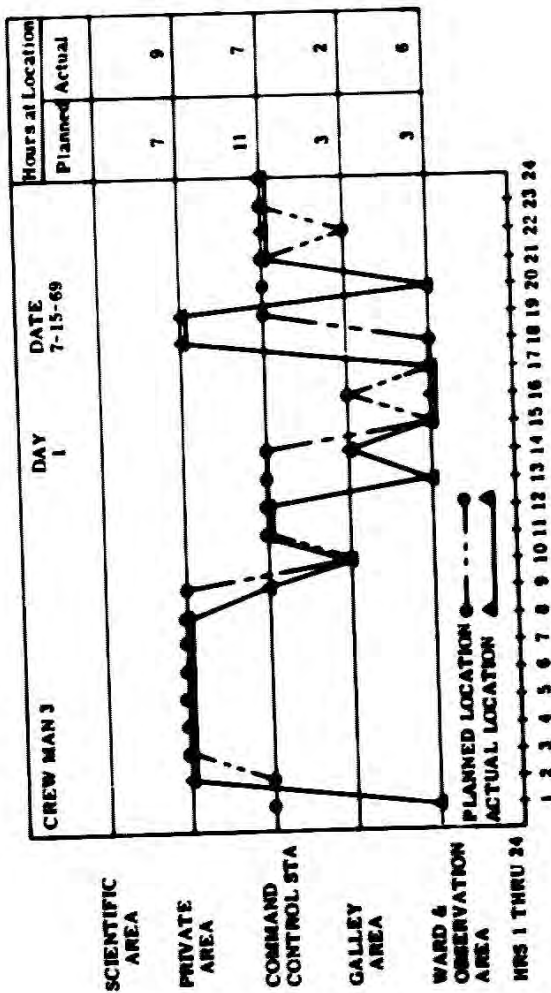

Day 1

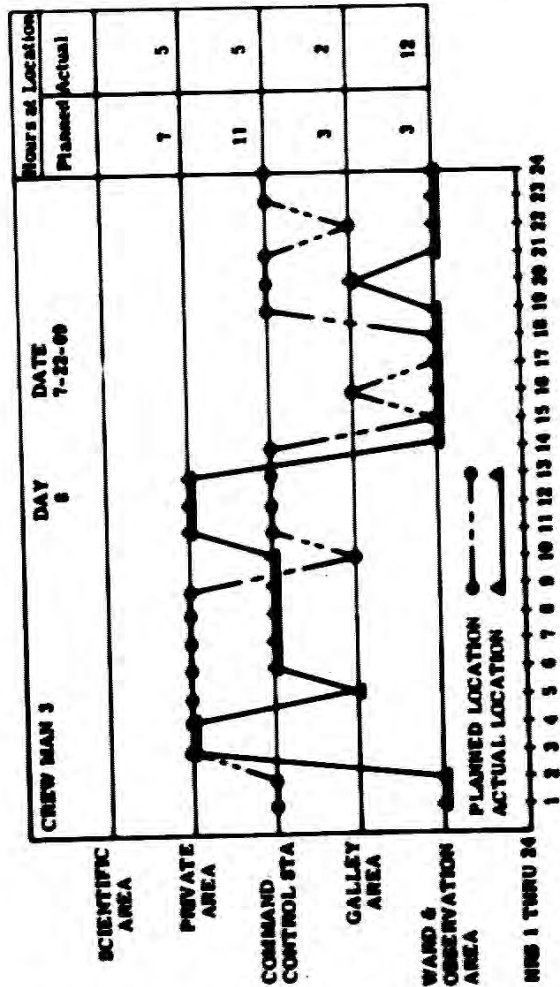

Day 8

Figure B-2. Actual Versus Planned Time Line, Man 3

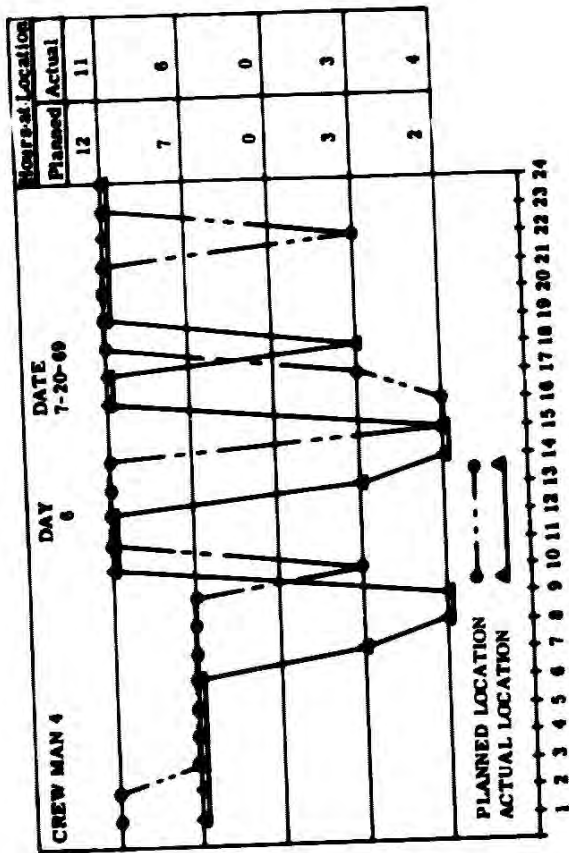

Day 6

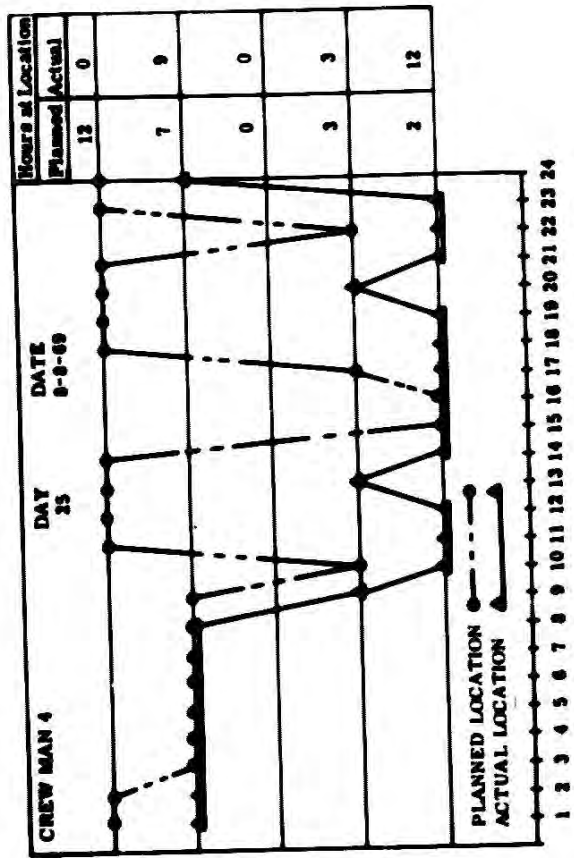

Day 25

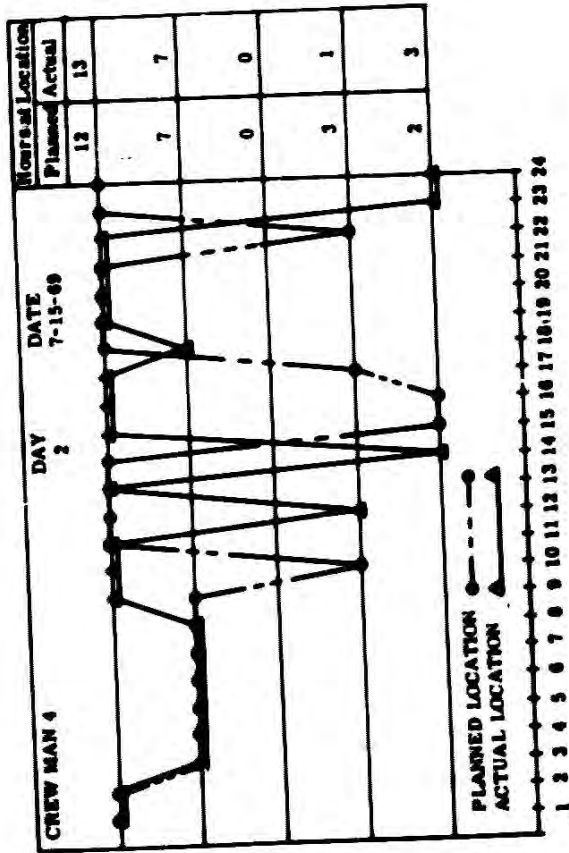

Day 2

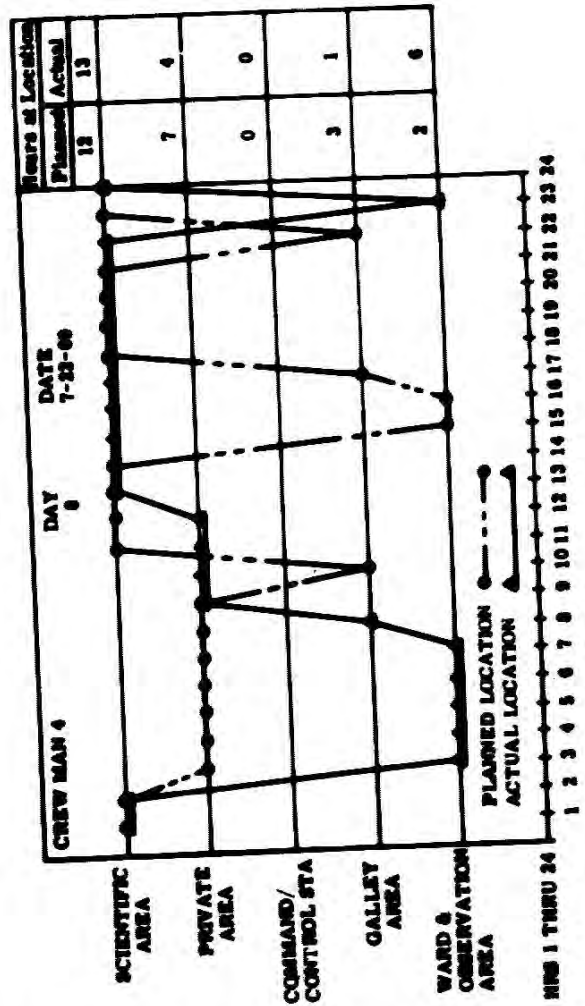

Day 8

SCIENTIFIC AREA

PRIVATE AREA

COMMAND/CONTROL STA

GALLEY AREA

WARD & OBSERVATION AREA

HRS 1 THRU 24

SCIENTIFIC AREA

PRIVATE AREA

COMMAND/CONTROL STA

GALLEY AREA

WARD & OBSERVATION AREA

HRS 1 THRU 24

Figure B-3. Actual Versus Planned Time Line, Man 4

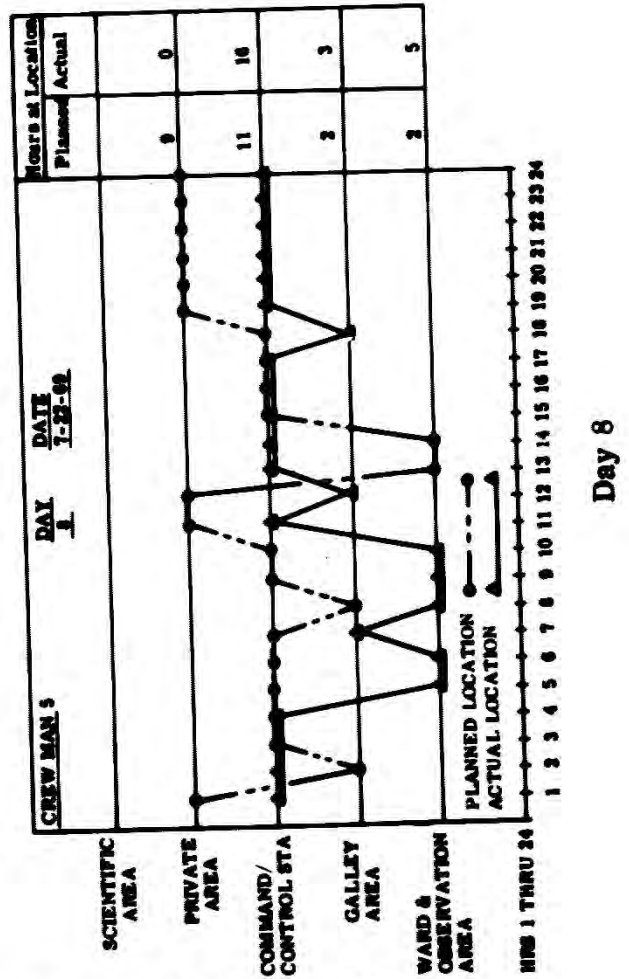
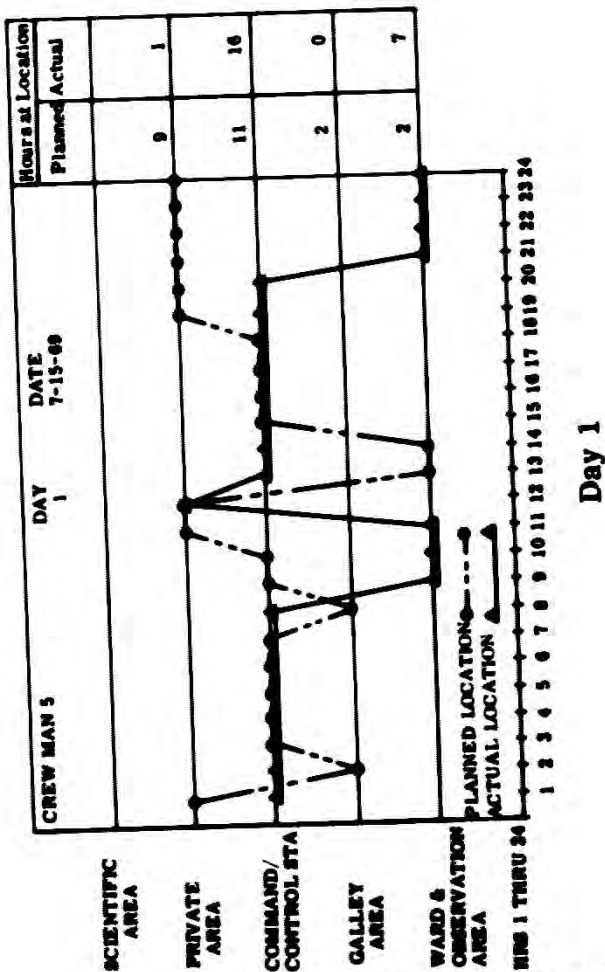
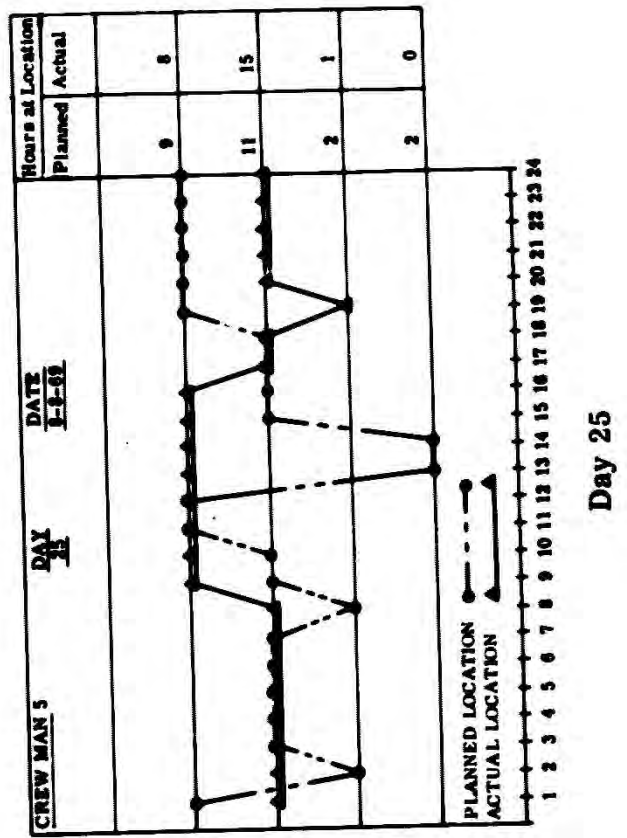
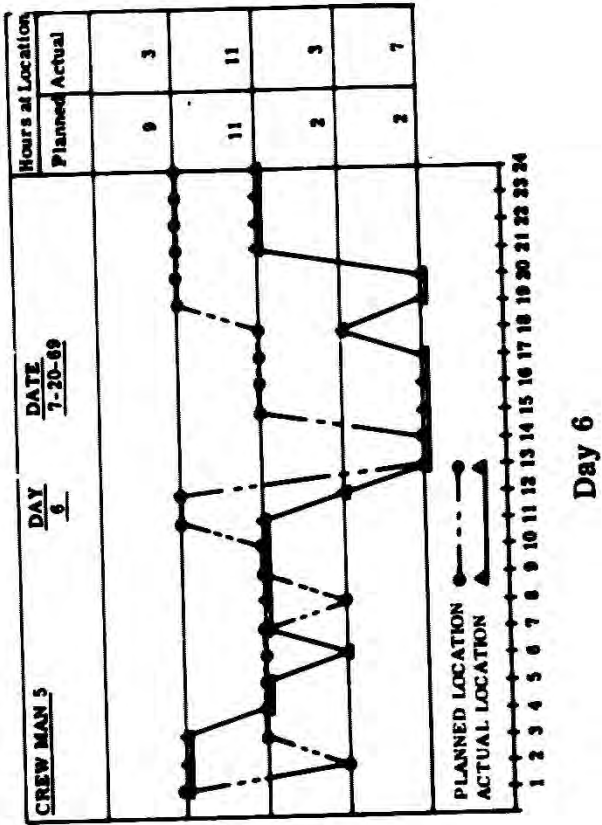
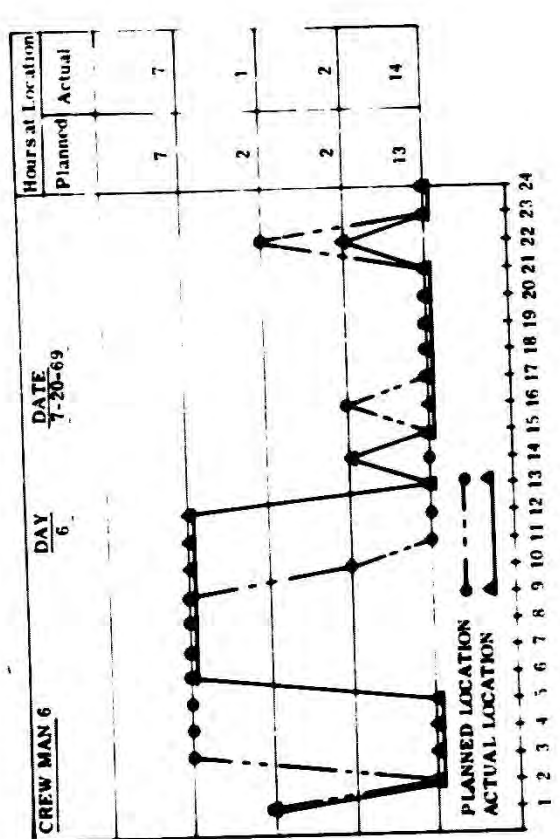
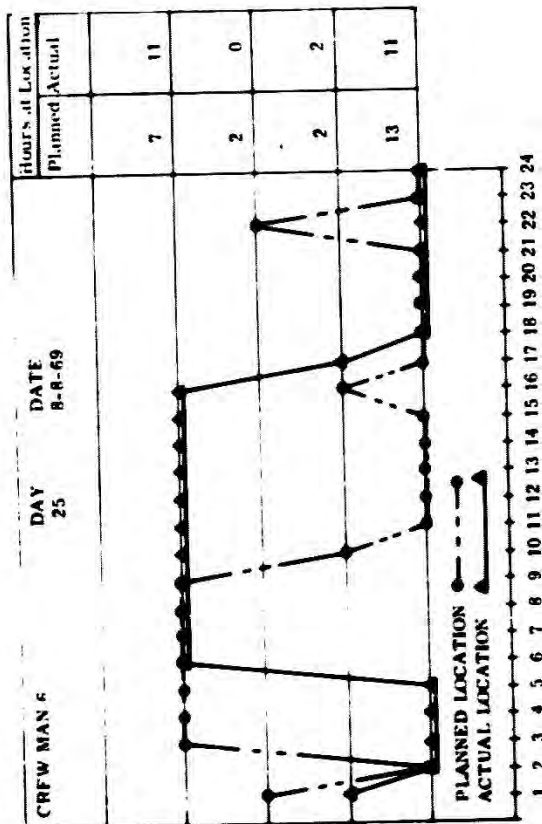

Figure B-4. Actual Versus Planned Time Line, Man 5



Day 6



Day 25

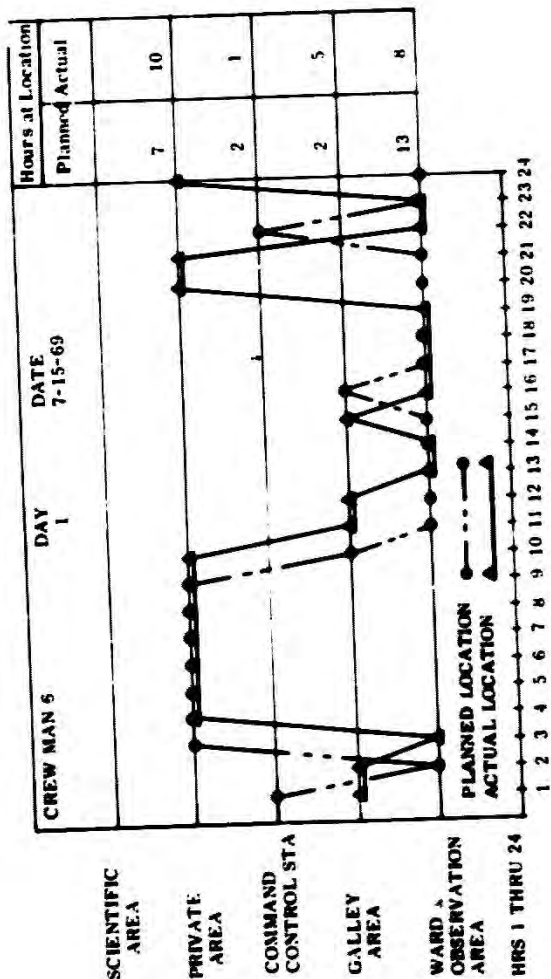

Day 1

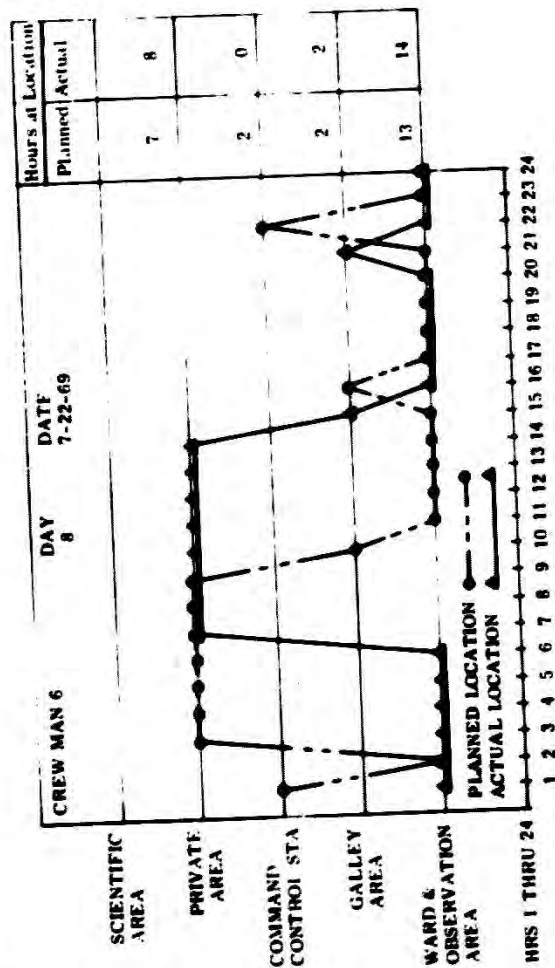

Day 8

Figure B-5. Actual Versus Planned Time Line, Man 6

APPENDIX C
INSTRUMENTS FOR ENVIRONMENT MEASUREMENT

C.1 INSTRUMENTS

The following paragraphs describes the measurements made and the equipment used.

C.1.1 Basic Atmospheric Constituents

C.1.1.1 Oxygen/Percent - Teledyne Oxygen Detector-Model No. 320-CA-2. Cell Class B-1, Range 0.25%, 0-100% Continuous readout, automatic operation (Sensor is a miniature fuel cell in which oxygen from the atmosphere reacts with material stored in the sensor element). The reaction generates an E. M. F. proportional to the oxygen partial pressure which in turn drives the indicator needle.

- **Fyrite Oxygen Indicator - Model CPD Scale 0-60%, hand operated, works on the principal of absorbing all of the oxygen from the sample, and has a calibrated scale.**

C.1.1.2 Carbon Dioxide/Percent - Fyrite CO₂ indicator Model CND Scale 0-76%, - Hand operated, works on the principal of absorbing all of the CO₂ from the sample and has a calibrated scale.

- **Dwyer Carbon Dioxide Indicator Model 800-5 Scale 0-5%, hand operated works on the principal of absorbing all of the CO₂ from sample and has a calibrated scale.**

C.1.2 Crew Comfort

C.1.2.1 Temperature - Internal - Abeon dial face thermometer No. Tab 63 circular face, -30° F to +130° F

- **External - Trub, Tauber and Cle-remote Sensor - Resistance reading - rectangular face, 0-50° C.**

C.1.2.2 Humidity - Abeon relative humidity indicator No. AB-62, circular face, 0-100%

C.1.2.3 Pressure - Circular face, scale in atmospheres

C. 1. 3 Trace Contaminants

Drager Multi-gas Detector Model 21/31. The model 21/31 kit consists of a model 31 hand operated bellows pump and thirty-eight different gas detector tubes. A complete listing of the detector tubes is presented in Figure A-1 and A-2.

C. 1. 4 Equipment Evaluation

Gas Chromatograph - Unico - Model PGC series 10. The entire unit, which consists of chromatograph, recorder and carrier gas supply is completely self contained in a durable molded fiberflass enclosure giving the appearance of a suitcase with dimensions of approximately 7" x 22" x '6", weight approximately 50 lbs. , requires 115 VAC, 50 Hz, 22VA. It operates at ambient temperatures for gas analysis and low boiling liquids. It may be employed either as a single column or a dual column instrument, which provides a closely regulated helium carrier flow to dual or single column injection. It has a very sensitive micro thermistor detector, which will permit quantitative analysis down to ppm. The instruments qualitative capabilities are dependant on the type of column employed.

C. 1. 5 Atomsphere Sampling Syringers

Glenco 25ml gas tight syringe. These syringes are hand operated. Ten syringes were provided for the mission with samples taken every third day, alternating forward and aft locations. At the end of the mission, samples were returned to laboratory for chromatographic analyses.

DRAGER DETECTOR TUBES

TRACE CONTAMINANTS

<u>PART NO.</u>	<u>DRAGER TUBE</u>	<u>(1) TUBE MEASURING RANGE</u>	<u>(1) PUMP STROKES</u>	<u>90 DAY</u>	<u>M. A. C. 24 HOUR</u>
Ch208	2/a Mercaptan	2-100 ppm	10		20 ppm
Ch211	50/a Trichloroethane	50-300 ppm	3	2.5	10 ppm
Ch229	100/b Acetone	100-1200 ppm	10	300	2000 ppm
Ch230	5/a Toluene	5-400 ppm	5		200 ppm
Ch231	0.1/a Mercury Vapor	0.1-2 mg/m ³	20-1	.01	2.0mg/m ³
Ch243	0.2/a Chlorine	0.2-30 ppm	10	.1	1 ppm
Ch244	10/a Trichlorethylene	1-400 ppm	5		*
Ch248	0.05 Benzene	15-420 ppm	20-2	1	100 ppm
Ch254	2 Hydrocarbon	2-25 mg/l	24-3		2 mg/l
Ch257	2/a Hydrocyanic Acid	2-150 ppm	5 & 1		10 ppm
Ch260	0.04 Carbon Disulphide	10-320 ppm	18-1		20 ppm
Ch261	0.1% Hydrocarbon	0.1-1 Vol. %	25-5		-
Ch264	0.002 Formaldehyde	2-40 ppm	5		*
Ch269	5/a Acrylonitrile	5-30 ppm	5		20 ppm
Ch273	5/b Methyl Bromide	5-50 ppm	5		20 ppm
Ch274	10/b Carbon Tetrachloride	10-100 ppm	3		10 ppm
Ch275	1/a Systox	1 m. g. a.	20		-
Ch276	50/a Monostyrene	50-400 ppm	11-2		100 ppm
Ch278	25/a Toluene	25-1860 ppm	10		200 ppm
CH283	0.25/b Phosgene	0.25-75 ppm	5 & 1	.05	0.1 ppm
Ch295	2/a Hydrochloric Acid	2-30 ppm	10	1	4 ppm

NOTES:

- (1) Refer to Drager Tube instruction sheet for full instructions.
 - (2) Maximum allowable concentration value is listed on Drager Tube instruction sheet.
- * Limit has not been established.

Figure C-1. Trace Contaminant Tubes (Sheet 1 of 2)

DRAGER DETECTOR TUBES

TRACE CONTAMINANTS (Continued)

<u>PART NO.</u>	<u>DRAGER TUBE</u>	<u>(1) TUBE MEASURING RANGE</u>	<u>(1) PUMP STROKES</u>	<u>90 DAY</u>	<u>M. A. C. 24 HOUR</u>
Ch297	100/a Alcohol	100-3000 ppm	10		200 ppm
Ch303	0.5/a Hydrogen Fluoride	0.5-15 ppm	20a. 10	.1	1 ppm
Ch307	10/a Perchloroethylene	10-400 ppm	3		100 ppm
Ch311	0.1/a Hydrogen Phosphide	0.1-4 ppm	10		0.1 ppm
Ch312	0.05%/a Olefins	1-50 mg/l	20-1		-
Ch313	0.05/a Ozone	0.05-1.4 ppm	10	.02	0.1 ppm
Ch315	5/a Phenol	5 ppm	10		5 ppm
Ch318	0.25/a Hydrazine	0.25-3 ppm	10		1 ppm

NOTES:

- (1) Refer to Drager Tube instruction sheet for full instructions.
 - (2) Maximum allowable concentration value is listed on Drager Tube instruction sheet.
- * Limit has not been established.

Figure C-1. Trace Contaminant Tubes (Sheet 2 of 2)

DRAGER DETECTOR TUBES METABOLIC CONTAMINANTS

PART NO.	DRAGER TUBE	(1) TUBE MEASURING RANGE	(1) PUMP STROKES	M. A. C. (2)	
				90 DAY	24 HOUR
Ch250	0.01/a Arsine	0.01-0.1 ppm	10-1	.01	0.1 ppm
Ch255	25/a Ammonia	25-700 ppm	10	25	50 ppm
Ch256	5/b Carbon Monoxide	5-200 ppm	10	25	200 ppm
Ch294	0.5/a Nitrous Gas	0.5010 ppm	5		(4)
Ch298	1/b Hydrogen Sulphide	1-600 ppm	10a.1	*	*
Ch300	0.5/c Nitrogen Dioxide	0.5-10 ppm	5	0.5	1 ppm
Ch309	0.5%/a Hydrogen	0.5-3 Vol. %	5		4% (3)
Ch314	0.5%/a Carbon Dioxide	0.5-10 Vol. %	1		15% Vol.
Ch317	1/a Sulphur Dioxide	1-40 ppm	10	1	5 ppm

NOTES:

- (1) Refer to Drager Tube instruction sheet for full instructions.
- (2) Maximum allowable concentration value from Nav Sups 0900-028-2010.
- (3) Lower combustion limit of Hydrogen in air.
- (4) 25 ppm NO₂ dangerous in about 30-60 minutes.

* Limit has not been established.

Figure C-2. Metabolic Contaminant Tubes

APPENDIX D
GULF STREAM DRIFT MISSION MENU

Meals for this mission are packed in two-man day increments, consisting of Breakfast, Lunch, Dinner and Snack with each meal individually sealed in a 3-mil thick polyethylene bag, and the full day's ration packaged within a heavy duty outer polyethylene bag.

The outer bag is planned as a garbage container at meal's end.

Meal preparation is accomplished by the addition of either hot or cold water only. No cooking is required, although in some cases soaking periods for longer than the minimum prescribed in the directions will enhance flavor.

This menu selection provides an average of approximately 3158 calories per man day.

It is recommended that the crew set aside unopened food packets for left-over utilization as desired.

All meals are numbered according to the following menus present in Figures D-1 through D-4.

BREAKFASTS (36 each)

	<u>Calories</u>	<u>Water</u>		<u>Weight</u>
		<u>Cold</u>	<u>Hot</u>	
B-1 Orange Crystals Familia/Milk/Sugar Tea/Sugar Coffee Mate Nut Roll	1410	32	16	12 oz.
B-2 Orange Crystals Instant Scrambled Egg Bacon Bar Pecan Roll Coffee/Sugar Coffee Mate	1642	16	32	13-1/2 oz.
B-3 Pineapple Crystals Familia/Milk/Sugar Fruitcake Coffee/Sugar Coffee Mate	2014	32	16	18 oz.
B-4 Grapefruit Crystals Frosted Flakes Milk (non-fat) Sugar Packs Nut Roll Coffee/Sugar Coffee Mate	1815	32	16	18 oz.
B-5 Pineapple Crystals Instant Scrambled Egg w/Bacon Bits Nut Roll Coffee/Sugar Coffee Mate	1658	16	32	15-1/2 oz.

Figure D-1. Breakfast Menu

LUNCHES (36 each)

	<u>Calories</u>	<u>Water</u> <u>Cold Hot</u>	<u>Weight</u> <u>10-1/2 oz.</u>
L-1 Deviled Ham Crackers Mustard Pea Soup Lemonade	<u>1171</u>	<u>16 16</u>	<u>10-1/2 oz.</u>
L-2 Tuna Salad Bread Peach Slices Grape Drink	1045	26 0	9-1/2 oz.
L-3 Chicken Salad Crackers Chocolate Milk Shake Cheese Orange Drink	1526	36 0	13-1/2 oz.
L-4 Egg Salad Bread Fruit Cocktail Beef Soup Lemonade	1105	30 16	10-1/2 oz.
L-5 Chicken Soup Peanut Butter Jelly/Honey Bread Grape Drink	1295	16 16	10-1/2 oz.

Figure D-2. Lunch Menu

DINNERS (36 each)

	<u>Calories</u>	<u>Water</u>		<u>Weight</u> 14-1/2 oz.
		<u>Cold</u>	<u>Hot</u>	
D-1	1646	22	44	
Beef Soup				
Beef/Rice Dinner or Beef Stew				
Carrots				
Crackers				
Chocolate Pudding				
Coffee/Sugar				
Coffee Mate				
Salt/Pepper				
D-2	2586	12	50	26 oz.
Chicken Soup				
Ham				
Apple Sauce				
Mashed Potato				
Peas & Carrots				
Coffee/Sugar				
Coffee Mate				
Salt/Pepper				
D-3	1603	12	62	16 oz.
Pea Soup				
Beef Stew				
Mashed Potato				
Peas				
Butterscotch Pudding				
Coffee/Sugar				
Coffee Mate				
Salt/Pepper				
D-4	1995	0	54	19 oz.
Chicken Soup				
Beef Patties				
Mashed Potato				
Peas				
Nut Roll				
Ketchup				
Coffee/Sugar				
Coffee Mate				
Salt/Pepper				
D-5	2496	20	44	23 oz.
Potato Soup				
Chicken Stew				
Carrots				
Crackers				
Fruit Cocktail				
Nut Roll				
Coffee/Sugar				
Coffee Mate				
Salt/Pepper				

Figure D-3. Dinner Menu

SNACKS (36 each)

	<u>Calories</u>	<u>Water</u>		<u>Weight</u>
		<u>Cold</u>	<u>Hot</u>	
S-1 Raisins (2) Chocolate Bars (2) Nuts	804	0		6 oz.
S-2 Fig Bars Cheese Chocolate Bars	880	0		7 oz.
S-3 Mandarin Oranges Raisins Nuts	724	0		10 oz.
S-4 Malted Milk Tablets Beef Jerky Chocolate Bars	654	0		5-1/2 oz.
S-5 Nut Roll Peaches Chocolate Bars	1415	12		13-1/2 oz.

Figure D-4. Snack Menu